



Technical Report

RadiaLE: A framework for designing and assessing link quality estimators in wireless sensor networks

Nouha Baccour

Anis Koubaa

Maissa Ben Jamâa

Denis do Rosário

Habib Youssef

Mário Alves

Leandro B. Becker

HURRAY-TR-110601

Version:

Date: 06-13-2011

RadiaLE: A framework for designing and assessing link quality estimators in wireless sensor networks

Nouha Baccour, Anis Koubaa, Maissa Ben Jamâa, Denis do Rosário, Habib Youssef, Mário Alves, Leandro B. Becker

IPP-HURRAY!

Polytechnic Institute of Porto (ISEP-IPP)

Rua Dr. António Bernardino de Almeida, 431

4200-072 Porto

Portugal

Tel.: +351.22.8340509, Fax: +351.22.8340509

E-mail:

<http://www.hurray.isep.ipp.pt>

Abstract

Stringent cost and energy constraints impose the use of low-cost and low-power radio transceivers in large-scale wireless sensor networks (WSNs). This fact, together with the harsh characteristics of the physical environment, requires a rigorous WSN design. Mechanisms for WSN deployment and topology control, MAC and routing, resource and mobility management, greatly depend on reliable link quality estimators (LQEs). This paper describes the RadiaLE framework, which enables the experimental assessment, design and optimization of LQEs. RadiaLE comprises (i) the hardware components of the WSN testbed and (ii) a software tool for setting-up and controlling the experiments, automating link measurements gathering through packets-statistics collection, and analyzing the collected data, allowing for LQEs evaluation. We also propose a methodology that allows (i) to properly set different types of links and different types of traffic, (ii) to collect rich link measurements, and (iii) to validate LQEs using a holistic and unified approach. To demonstrate the validity and usefulness of RadiaLE, we present two case studies: the characterization of low-power links and a comparison between six representative LQEs. We also extend the second study for evaluating the accuracy of the TOSSIM 2 channel model.

Provided for non-commercial research and education use.
Not for reproduction, distribution or commercial use.

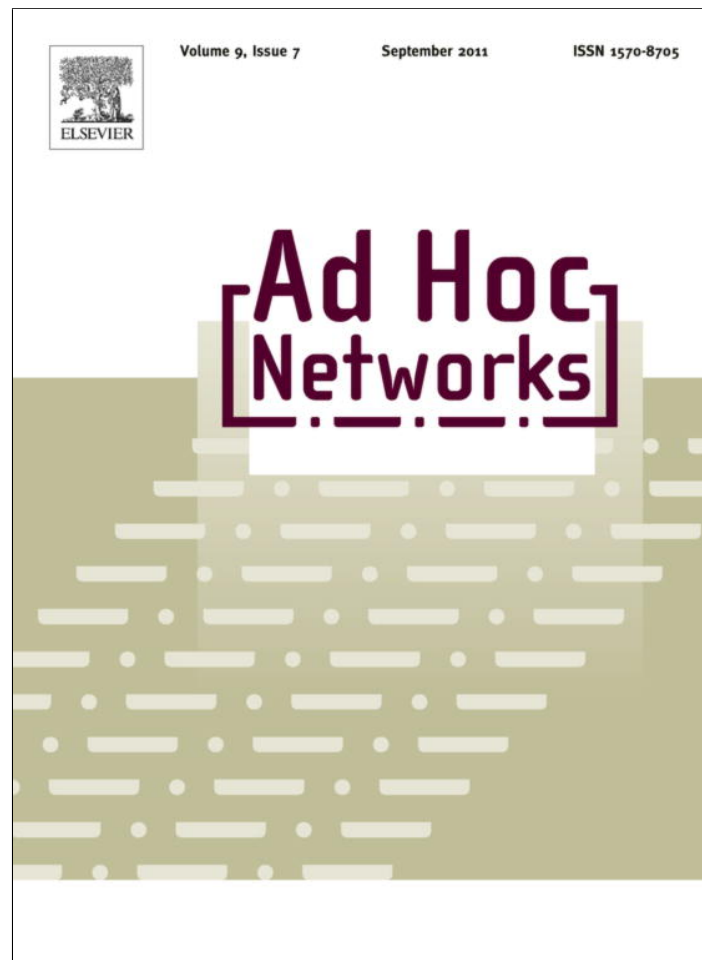

This article appeared in a journal published by Elsevier. The attached copy is furnished to the author for internal non-commercial research and education use, including for instruction at the authors institution and sharing with colleagues.

Other uses, including reproduction and distribution, or selling or licensing copies, or posting to personal, institutional or third party websites are prohibited.

In most cases authors are permitted to post their version of the article (e.g. in Word or Tex form) to their personal website or institutional repository. Authors requiring further information regarding Elsevier's archiving and manuscript policies are encouraged to visit:

<http://www.elsevier.com/copyright>



Contents lists available at ScienceDirect

Ad Hoc Networks

journal homepage: www.elsevier.com/locate/adhoc

RadiaLE: A framework for designing and assessing link quality estimators in wireless sensor networks

Nouha Baccour^{a,b,*}, Anis Koubâa^{b,c}, Maissa Ben Jamâa^a, Denis do Rosário^{b,e},
Habib Youssef^d, Mário Alves^b, Leandro B. Becker^e

^aReDCAD Research Unit, University of Sfax, Tunisia

^bCISTER Research Unit, Polytechnic Institute of Porto (ISEP/IPP), Portugal

^cCOINS Research Group, Al-Imam Mohamed bin Saud University (CCIS-IMAMU), Riyadh, Saudi Arabia

^dPrince Research Unit, University of Sousse, Tunisia

^eFederal University of Santa Catarina, Brazil

ARTICLE INFO

Article history:

Received 13 March 2010

Received in revised form 3 January 2011

Accepted 8 January 2011

Available online 18 January 2011

Keywords:

Experimentation

Testbed

Measurements

Traffic pattern

Link quality estimation

Channel

Performance

ABSTRACT

Stringent cost and energy constraints impose the use of low-cost and low-power radio transceivers in large-scale wireless sensor networks (WSNs). This fact, together with the harsh characteristics of the physical environment, requires a rigorous WSN design. Mechanisms for WSN deployment and topology control, MAC and routing, resource and mobility management, greatly depend on reliable link quality estimators (LQEs). This paper describes the RadiaLE framework, which enables the experimental assessment, design and optimization of LQEs. RadiaLE comprises (i) the hardware components of the WSN testbed and (ii) a software tool for setting-up and controlling the experiments, automating link measurements gathering through packets-statistics collection, and analyzing the collected data, allowing for LQEs evaluation. We also propose a methodology that allows (i) to properly set different types of links and different types of traffic, (ii) to collect rich link measurements, and (iii) to validate LQEs using a holistic and unified approach. To demonstrate the validity and usefulness of RadiaLE, we present two case studies: the characterization of low-power links and a comparison between six representative LQEs. We also extend the second study for evaluating the accuracy of the TOSSIM 2 channel model.

© 2011 Elsevier B.V. All rights reserved.

1. Introduction

Wireless sensor networks (WSNs) typically have severe constraints on energy consumption since nodes have to survive on a limited battery energy for extended periods of time, up to several years. This fact brings network protocols designers to provide energy-efficient solutions, namely in what concerns medium-access control (MAC),

routing, mobility management, and topology control protocols. One of the most important requirements to achieve this goal is to avoid excessive retransmissions over low quality links. Therefore, link quality estimation emerges as a fundamental building block for network protocols to maximize the lifetime, the reliability, and the throughput of WSNs.

Several link quality estimators (LQEs) have been reported in the literature (e.g. [1–5]). They can be classified as either hardware-based or software-based. Hardware-based LQEs, such as Link Quality Indicator (LQI), Received Signal Strength Indicator (RSSI) and Signal to Noise Ratio (SNR) are directly read from the radio transceiver (e.g. the CC2420) upon packet reception. Most software-based LQEs enable to either count or approximate the packet

* Corresponding author at: ReDCAD Research Unit, University of Sfax, Tunisia. Tel.: +216 22724382; fax: +216 74666578.

E-mail addresses: nabr@isep.ipp.pt (N. Baccour), aska@isep.ipp.pt (A. Koubâa), mberj@redcad.org (M. Ben Jamâa), dlr@isep.ipp.pt (D. do Rosário), habib.youssef@fsm.rnu.tn (H. Youssef), mjf@isep.ipp.pt (M. Alves), lbecker@das.ufsc.br (L.B. Becker).

reception ratio or the average number of packet transmissions/retransmissions.

The accuracy of link quality estimation greatly impacts the efficiency of network protocols. For instance, many routing protocols, e.g. [2,6,7], rely on link quality estimation to select high quality routes for communication. The more accurate the link quality estimation is, the more correct the decision made by routing protocols in selecting such routes. This is just one example on how important it is to assess the performance of the LQE before integrating it into a particular network protocol.

The experimental performance evaluation of LQEs requires performing link measurements through packet-statistics collection. Several testbeds have been designed for the experimentation (test, validation, performance evaluation, etc.) of WSNs [8–12], but only [13,14] targeted link measurements. However, these were exploited for analyzing low-power link characteristics rather than for the performance evaluation of LQEs. Namely, they do not provide sufficient data to compute most LQEs, especially sender-side ones (refer to Section 3.2 for further intuition on sender-side and receiver-side LQEs).

Despite its importance, the experimental performance evaluation of LQEs remains an open problem. One of the reasons is the impossibility, or at least the difficulty, to provide a quantitative evaluation of the accuracy of LQEs. In fact, there is no objective link quality metric to which the link quality estimate can be compared. Furthermore, there are LQEs that are based on the packet reception ratio (PRR), some others are based on packet retransmission count (i.e. RNP) and some others are hybrid and more complex. Thus, comparing their performance becomes challenging as they have different natures. These facts motivated us to build a framework – RadiaLE, aiming at the experimental evaluation, design and optimization of LQEs.

The RadiaLE framework [15] comprises (i) hardware components of the WSN testbed and (ii) a software tool for setting-up and controlling the experiments and also for analyzing the collected data, allowing for LQEs evaluation. In fact, RadiaLE is much more than an experimental testbed. It stands for a methodology that allows researchers (i) to properly set different types of links and different types of traffics, (ii) to collect a rich database of link measurements, and (iii) to validate their solutions using a holistic and unified approach. Furthermore, RadiaLE can be used to validate the accuracy of the channel model of network simulators by replaying the performed experiments using the simulator under consideration and comparing the simulation results against the experimental results.

This paper makes the following three main contributions:

- First, we propose RadiaLE, a new experimental testbed dedicated to perform the empirical evaluation of link quality estimators (Sections 3 and 4).
- Second, we present an empirical study demonstrating the capabilities of RadiaLE for the characterization of low-power links and the performance evaluation of LQEs (Section 5).

- Third, we examine the accuracy of the wireless channel model of TOSSIM 2 by comparing simulation results with empirical results obtained with RadiaLE (Section 6).

2. Related work

Several testbeds have been designed for the experimentation of WSNs. They can be classified into *general-purpose* testbeds and *special-purpose* testbeds. Most of existing testbeds, including MoteLab [8], Mirage [9], Twist [10], Kansei [11], and Emulab [12] are general-purpose testbeds. They have been designed and operated to be remotely used by several users with different research objectives. On the other hand, dedicated testbeds, such as Scale [13] and Swat [14] are designed for a specific research objective. This section overviews on some well-known WSN testbeds, according to the two classes.

2.1. General-purpose testbeds

Roughly, testbeds of this class have four building blocks: (i) the underlying WSN, (ii) a network backbone providing reliable channels to remotely control sensor nodes, (iii) a server that handles sensor nodes reprogramming and data logging into a database, and (iv) a web-interface coupled with a scheduling policy to allow the testbed sharing among several users. The testbed users must be experts on the programming environment supported by the testbeds (e.g. TinyOS, Emstar), to be able to provide executable files for motes¹ programming. They must also create their own software tool to analyze the experimental data and produce results. Next, we present an overview on some testbeds from this category.

MoteLab [8] is a very popular testbed. Currently, MoteLab consists of 190 TMote Sky motes, deployed over three floors of Harvard's Engineering building. Each mote is connected to a central server via an Ethernet connection. This server handles motes reprogramming and data logging into a MySQL database, through a web interface. The web interface enables an authorized user to create a *job* while (i) setting job parameters, such as starting time, duration, number of nodes, enabling/disabling power profiling, and (ii) uploading the executable files: a binary image obtained from TinyOS environment, and a class file. Once created, the user submits the job and runs the experiments. When the experiment finishes, he can access to the experimental data (collected statistics). MoteLab provides a scheduling mechanism to ensure the sharing of testbed resources between multiple users. In [9], it has been argued that MoteLab uses a simple and non-efficient scheduling mechanism for the testbed nodes sharing and allocation. Therefore, the authors of [9] proposed a solution, called Mirage, that applies the concepts of microeconomic resource allocation, for a better allocation and sharing of the testbed nodes.

¹ We use terms "Sensor nodes" and "motes" interchangeably along the text.

Twist [10] is very similar to the Motelab testbed (referring to its latest implementation). The Twist instance at the TKN Office Building consists of 204 sensor nodes, divided between eyesIFX and Tmote Sky motes, and placed in a grid topology with an inter-node distance of 3 m. All motes communicate with a server and a control station through a hierarchical backbone. The principal role of the server is maintaining a database that stores experimental data. The control station enables to configure and monitor the WSN. The hierarchical backbone comprises USB hubs that connect sensor nodes to special devices called “super-nodes”, which are in turn connected to the server and the control station through Ethernet. Twist uses Network Storage Link for USB2.0 (NSLU2 from Linksys) as super-nodes devices. The super-nodes run Python scripts that are invoked remotely by the control station to provide functionalities such as sensor node programming (using TinyOS environment) experiment debugging and data collection. Twist also provides a web interface that enables users access to the testbed and running experiments.

Kansei [11] was developed for large-scale sensing experiments. Its stationary array consists of 210 dual nodes, a combination of one Extreme Scale Stargate (XSS) node and one Extreme Scale Mote (XSM) node, all placed on a rectangular grid. The XSM nodes are sensor motes that are specially designed for the Kansei testbed. Each sensor node is attached to a XSS node, which is a personal computer (PC) with a IEEE 802.11b board. Kansei uses both Ethernet and WiFi to connect sensor nodes to the server. Like Motelab, Kansei testbed uses a server that handles motes reprogramming and data logging while providing a web interface, but Kansei allows richer interaction with motes. For instance, in Kansei, sensor nodes infrastructure is coupled with one or more portable arrays for in-situ recording of sensor data, and other management tasks. Kansei uses the EmStar software framework [16] to upload executables, schedule jobs, and retrieve raw data.

Emulab [12,17] was developed for mobile sensor networks. The testbed is composed of four mobile nodes and 25 static nodes. The static nodes are Mica2 motes that integrate serial programming boards, to control them. Each mobile node is designed as a Garcia mobile robot carrying a Stargate single-board computer with a IEEE 802.11b board, and a Mica2 mote. The Stargate is used to control the mobile node. The mobile nodes are roaming in a 60 m² L-shaped area. Through a web-based, user interface-driven or programmable XML-RPC user interface, an authorized user can configure and run WSNs experiments with dynamic topologies. It has full control over mobile nodes: can specify their motion, track their positions, reprogram motes and log data (packets-statistics, experiment motion history, etc.).

Emulab, Mirage, and Kansei use serial interfaces; and Twist and Motelab use USB interfaces, in order to access sensor nodes. In [18], it has been argued that such wired connections do not allow for large-scale WSNs deployment. Deployment Support for sensor Networks (DSN) [18], is a secondary wireless multi-hop network that has been introduced as a backbone solution for WSN testbeds. The backbone is used to retrieve data (packet-statistics) from the sensor nodes and to control them by sending di-

rect commands. It is composed of DSN-nodes. Each DSN-node is attached to a sensor node. In their implementation of DSN, the authors in [18] have chosen Bluetooth as a wireless transport layer and BTnode as a platform for DSN-nodes. Further, they provided modules for data forwarding and topology control to optimize the connectivity and the reliability of the backbone DSN network.

Testbeds of this first category might be not suitable for assessing LQEs. Their tendency to cover multiple research objectives prevent them from satisfying some particular requirements. Namely, the physical topology of sensor nodes as well as the environment conditions cannot be managed by the user. However, to assess the performance of LQEs, it is mandatory to design a network topology, where the underlying links are of different qualities. Especially, it is highly recommended to have links with moderate quality and dynamic behavior.

2.2. Special-purpose testbeds

Many researchers develop their own testbeds to achieve a specific goal. These belong to the category of dedicated testbeds. To our best knowledge, none of the existing testbeds was devoted to the performance evaluation of LQEs. Some testbeds have been dedicated to link measurements, such as SCALE [13] and SWAT [14], but they were exploited for analyzing low-power link characteristics rather than the performance evaluation of LQEs.

SCALE [13] is a tool for measuring the Packet Reception Ratio (PRR) LQE. It is built using the EmStar programming model. Each sensor node runs a software stack, allowing for sending and receiving probe packets in a round-robin fashion, retrieving packet-statistics, and sending them through serial communication. All sensor nodes are connected to a central PC via serial cables and serial multiplexors. The PC runs different processes – one for each node in the testbed – that perform data collection. Based on the collected data, other processes running on the PC allow for connectivity assessment through the derivation of the PRR of each unidirectional link. Thus, the network connectivity can be visualized during the experiment runtime.

SWAT [14] is a tool for link measurements. The supported link quality metrics (or LQEs) include PRR and hardware-based metrics: RSSI, LQI, noise floor, and SNR. SWAT uses the same infrastructure as SCALE: sensor nodes (MICA2 or TelosB) are connected through serial connections or Ethernet to a central PC. SWAT provides two user-interfaces (UIs), written in HTML and PHP. Through the HTML UI, users can specify the experiment parameters. The interface invokes Python scripts to ensure host-mote communication for performing specific operations, namely sending commands to motes (to control them) and storing raw packet-statistics retrieved from motes into a database. The PHP UI is used to set-up link quality metrics, and to collect some statistics such as PRR over time and correlation between PRR and RSSI. Then the UI invokes Python scripts to process the collected data and display reports.

SCALE is compatible with old platforms (MICA 1 and MICA 2 motes) which do not support the LQI metric. This metric has been shown as important to understand and

analyze channel behavior in WSNs [19]. On the other hand, SWAT is not practical for large-scale experiments, as some configuration tasks are performed manually. Both SWAT and SCALE allow for link measurements through packet-statistics collection but the collected data do not enable to compute various LQEs, namely sender-side LQEs, such as four-bit [1,20] and RNP [4]. The reason is that SWAT and SCALE do not collect sender-side packet-statistics (e.g. number of packet retransmissions).

Most of the existing testbeds use one-Burst traffic, where each node sends a burst of packets to each of their neighbors and then passes the token to the next node to send its burst. This traffic pattern cannot accurately capture the link *Asymmetry* property as the two directions (uplink and downlink) will be assessed in separate time windows. Thus, traffic patterns that improve the accuracy of link asymmetry assessment are mandatory. In addition, as it has been observed in [21], the traffic Inter-packets Interval has a noticeable impact on channel characteristics. For that reason, it is important to understand the performance of LQEs for different traffic configurations/patterns.

In what follows, we present RadiaLE, our testbed solution that overcomes the above mentioned deficiencies in the existing testbeds. Especially, RadiaLE presents the following advantages/contributions:

- Provides abstractions to the implementation details by enabling its users to configure and control the network, as well as analyzing the collected packet-statistics database, using user-friendly graphical interfaces.
- Due to the flexibility and completeness of the collected database, a wide range of LQEs can be integrated in RadiaLE.
- Supports two traffic patterns, *bursty* and *synchronized*, having different parameters that can be tuned by the user in the network configuration step.
- Provides a holistic and unified methodology (by the mean of graphical user-interfaces) for the performance evaluation of LQEs.
- The RadiaLE software is publicly available as an open-source at [15], together with all relevant information and supporting documentation (e.g. installation and user guides).

We would like to note that RadiaLE can be complementary to General-purpose testbeds. In fact, as we have stated above, General-purpose testbeds such as MotelLab provide a remote access to their WSN so that researchers can easily perform experiments at their location. However, users have to provide the necessary code for communication, inter-nodes and between nodes and the remote computer. Hence, the idea is that RadiaLE users that do not have a WSN platform can use our free RadiaLE software tool together with the sensor nodes provided by a General-purpose testbed. As a matter of fact, we have tested RadiaLE software on the MotelLab testbed in order to perform large-scale experiments. In these experiments we studied the impact of LQEs on CTP (Collection Tree routing Protocol) [6], but this study is not addressed in this paper.

3. Methodology

RadiaLE allows researchers to evaluate the performance of LQEs by analyzing their statistical properties, independently of any external factor, such as collisions (each node transmits its data in an exclusive time slot) and routing (a single-hop network). These statistical properties impact the performance of LQEs, in terms of:

- *Reliability*: It refers to the ability of the LQE to correctly characterize the link state. RadiaLE provides a *qualitative* evaluation of the LQE reliability by analyzing (i) its temporal behavior, and (ii) the distribution of link quality estimates, illustrated by a scatter plot and an empirical cumulative distribution function (CDF).
- *Stability*: It refers to the ability to resist to transient (short-term) variations (also called fluctuations) in link quality. RadiaLE evaluates the stability of a LQE *quantitatively* by computing the coefficient of variation (CV) of its estimates. The CV of a random variable (e.g. a link quality estimator) is defined as the ratio of the standard deviation to the mean value.

It should be pointed out, that in link quality estimation there is a lack of a real metric of reference based on which the accuracy of the estimators can be assessed. In fact, in classical estimation theory an estimated process is typically compared to a real known process using a certain statistical tool (e.g. least mean square error or regression analysis). However, such comparison is not possible in link quality estimation, since: (1) there is no metric that is considered as the "real" one to represent link quality; and (2) link quality is represented by quantities with different natures, since some estimators are based on the computation of the packet reception ratio (PRR), some others are based on packet retransmission count (i.e. RNP) and some others are hybrid and more complex, as it will be presented in Section 4.2.6.

In addition to the above functionalities, RadiaLE enables a better design of new link quality estimation solutions through the understanding of low-power link characteristics and channel behavior. Indeed, RadiaLE generates a set of graphics that illustrate important link properties, including spatial and temporal variations, link quality asymmetry, etc.

To provide the aforementioned functionalities, RadiaLE has been designed according to a three-step methodology:

3.1. Links establishment

The first step consists of establishing a rich set of links exhibiting different properties, i.e. different qualities, to explore the spatial properties with high accuracy, and in particular the transitional region behavior. For that purpose, RadiaLE relies on setting-up a single-hop network, where nodes N_2, \dots, N_m are placed in different circles around a central mote N_1 , as shown in Fig. 1. The distance (in meters) between two consecutive circles is denoted as y , and the first circle that is the nearest to N_1 has a radius of x meters.

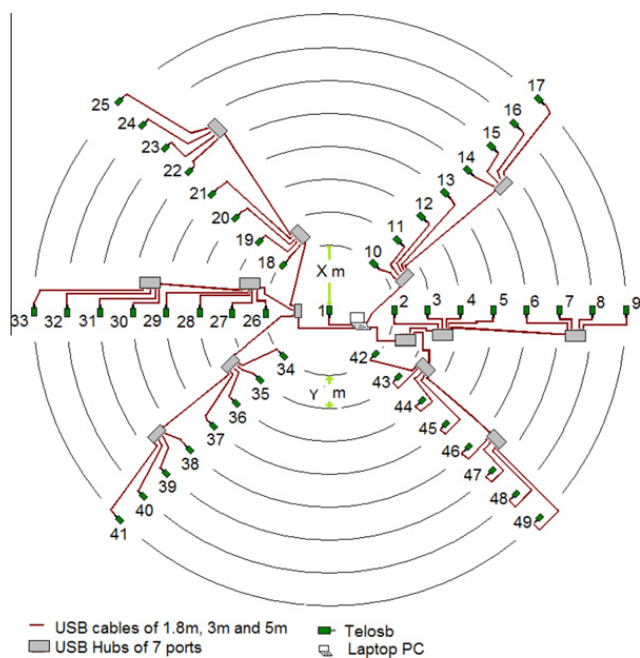

Fig. 1. Nodes distribution according to the radial topology.

Since distance and direction are fundamental factors that affect the link quality, the underlying links $N_1 \leftrightarrow N_i$ will have different characteristics (qualities) by placing nodes N_2, \dots, N_m at different distances and directions from the central node N_1 . Thus, it is recommended to empirically determine the appropriate x and y values, prior to experiments, to better explore the spatial characteristics of the transitional region, which is typically quantified in the literature by means of the PRR (Packet Reception Ratio).

In addition, network settings also impact the quality of the underlying links. Thus, RadiaLE allows the user to configure a couple of important network parameters before running the experiment. Network parameters include traffic type and related parameters, packet size, radio channel, enabling/disabling link layer retransmissions, maximum retransmission count, and the transmission power.

Although the RadiaLE testbed is independent from the underlying topology, a radial topology exacerbates its effectiveness. This is true since: (1) deploying nodes at different distances (6, in our case study) from a central node enables to attain different link qualities (within the transitional region); and (2) deploying nodes in several different axes (8, in our case study), enables to encompass the non-isotropic characteristics of radio communication. This is why we relied on a radial topology to perform our experimental study, which is presented in Section 5.3. This approach enabled consistent experimental results that pertain to the spatial and temporal behavior of link quality, and to the comparison of the different LQEs under evaluation.

3.2. Link measurements collection

The second step is to create a bidirectional data traffic over each link $N_1 \leftrightarrow N_i$, enabling link measurements through packet-statistics collection. Packet-statistics col-

lection consists of retrieving statistics, such as packet sequence number, from both sent and received packets.

RadiaLE provides two traffic patterns: $Burst(N, IPI, P)$ and $Synch(W, IPI)$ (refer to Fig. 3). $Burst(N, IPI, P)$ refers to a bursty traffic pattern, where the central node N_1 first sends a burst of packets to a given node N_i . Then, node N_i sends its burst of packets back to N_1 . This operation is repeated for P times, where P represents the total number of bursts. A burst is defined by two parameters: N , the number of packets in the burst and IPI, the Inter-Packets Interval. On the other hand, $Synch(W, IPI)$ refers to the synchronized traffic, where N_1 and N_i are synchronized to exchange packets in a round-robin fashion. This traffic is characterized by two parameters: IPI and the total number of sent packets, denoted by W .

In fact, to accurately assess link asymmetry, it is necessary to collect packet-statistics on both link directions at (almost) the same time. Therefore, the synchronized traffic pattern would be more convenient than the bursty traffic pattern (in particular for large bursts) to evaluate link asymmetry. Most of the existing testbeds rely on bursty traffic with only one burst. This traffic pattern is definitely inappropriate for the assessment of link asymmetry.

Another reason to support two traffic patterns in RadiaLE is that radio channels exhibit different behaviors with respect to these two traffic patterns, as it will be shown in Section 5.2.3. In [21], it has been observed that the traffic Inter-Packets Interval (IPI) has a noticeable impact on channel characteristics. For that reason, it is important to understand the performance of LQEs for different traffic configurations.

Exchanged traffic over each link allows for link measurements through packet-statistics collection. Some packet-statistics are evaluated at the receiver side (from received packets) such as global sequence number, timestamp, RSSI, LQI, and background noise. Such data is necessary to compute receiver-side LQEs. On the other hand, sender-side LQEs require other statistics collected at the sender side, such as sequence number, timestamp, packet retransmission count. All these packet-statistics are forwarded through a USB connection to a central PC and then stored in a database for statistical analysis.

3.3. Data analysis

An important step in the data analysis is to generate link quality estimates with respect to each LQE, based on the stored empirical data and the settings provided by the user, namely the estimation window and LQEs parameters. In fact, LQEs are computed off-line, which constitute one of the interesting features of RadiaLE as it enables to perform statistical analysis of LQEs with different settings without the need to repeat experiments. Data analysis allows to generate several statistical graphics for these LQEs, such as the empirical distribution and the coefficient of variation, which enables to assess the reliability and the stability of LQEs.

Data analysis includes also the functionality of generating a set of configurable graphics, allowing to study the spatial and temporal characteristics as well as the asymmetry of the underlying links. Such graphics help to design new LQEs by understanding the channel behavior.

4. RadiaLE implementation

This section describes the hardware and software architectures of RadiaLE, shown in Fig. 2a and b, respectively.

4.1. Hardware components

The hardware architecture, roughly illustrated in Fig. 2a, involves three main components: the sensor nodes, the USB tree, and the control station (e.g. laptop PC).

4.1.1. Sensor nodes

The sensor nodes are programmed in nesC [22] over TinyOS 2.x [23]. They do not rely on a particular communicating technology such as Zigbee or 6LowPAN. They also do not use any particular protocol at MAC and network layers. In fact, we have designed traffic patterns that avoid collisions; and we have deployed a single-hop network in order to analyze the statistical properties of LQEs independently any external factor.

In our instantiation of RadiaLE, we deployed 49 TelosB motes [24], which are equipped with IEEE 802.15.4 radio compliant chip, namely the CC2420 radio chip [25]. Other platforms (e.g., MICAz) and other radio chips (e.g., CC1000) can also be used with the RadiaLE framework. This requires some minor modifications at RadiaLE software tool (specifically, the Experiment Control Application and the nesC application). In fact, if other platforms other than TelosB but based on the CC2420 radio chip are used, modifications should only concern the computation of the sensor measures (e.g., temperature, humidity, and light). On the other hand, if different platforms based on other radio chips other than the CC2420 are used, additional modifications concerning RSSI and LQI reading, and channel setting should be carried out.

4.1.2. USB tree

The 49 motes are connected to a control station (PC) via a combination of USB cables and active USB hubs constituting a USB tree. This USB tree is used as a reliable logging/control channel between the motes and the PC.

Using passive USB cables, serial data can only be forwarded over distances that do not exceed 5 m. RadiaLE uses active USB hubs, daisy-chained together, depending on the distance between the sensor node and the PC (refer to Fig. 2), in order to forward serial data over large distances. Active USB hubs are also useful to connect a set of devices (motes or other USB hubs) as shown in Fig. 2, and provides motes with power supply.

4.2. Software components

RadiaLE provides a software tool, running on the PC, composed of two independent applications, as shown in Fig. 2b. The first application, developed in Java, is the Experiment Control Application (ExpCtrApp). It provides user-interfaces to ensure multiple functionalities, namely motes programming/control, network configuration and data logging into a MySQL database. The second application, developed in MATLAB, serves for an off-line data analysis (DataAnlApp). It provides various graphics for both links characterization and performance evaluation of LQEs. Next, we describe the aforementioned RadiaLE functionalities.

4.2.1. Motes programming

We have developed a nesC application that defines a set of protocols for any bidirectional communication between the motes and between the motes and the ExpCtrApp. The ExpCtrApp automatically detects the motes connected to the PC (through the USB tree) and programs them by installing the nesC application binary code. Automatic node detection is a new functionality that does not exist in other experimental testbeds and that is very practical in particular for larger deployments.

4.2.2. Network configuration

The ExpCtrApp enables the user to specify network parameters (e.g. traffic pattern, packets number/size, inter-packet interval, radio channel, transmission power, link layer retransmissions enabling/disabling and maximum

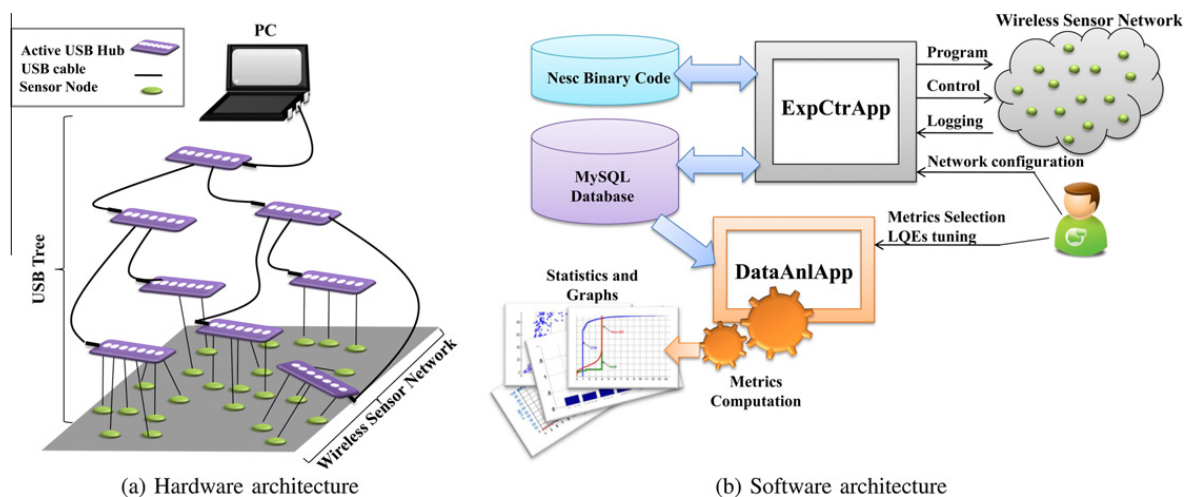

Fig. 2. RadiaLE hardware and software architectures.

count). These settings are transmitted to the motes to start performing their tasks.

4.2.3. Link measurements collection

Motes exchange data traffic in order to collect packet-statistics such as sequence number, RSSI, LQI, SNR, time-stamp or background noise, which are sent via the USB tree to the ExpCtrApp in the PC, which stores these log data into a MySQL database.

4.2.4. Motes control

The ExpCtrApp sends commands to and receive reports from the motes to control data transmission according to the traffic pattern set at the network configuration phase. Fig. 3 illustrates the implementation of the bursty and synchronized traffics. Particularly, this figure shows the interaction between the PC (i.e. ExpCtrApp) and two motes constituting the link $N_1 \leftrightarrow N_i$, through commands exchange.

In addition to the above functionalities, the ExpCtrApp provides two other that help the user to follow the experiment progress in real-time: (i) a *network viewer* that displays (in real-time) the network map, link quality metrics (e.g. PRR, RSSI), and the sensor node status (e.g. remaining power); and (ii) a *database inspector* that helps to view raw data retrieved from the motes in real-time.

4.2.5. Data analysis

The DataAnlApp application processes data stored in the database to provide two major functionalities, by the mean of user-friendly graphical interfaces (for some snapshots of these interfaces, please refer to [15], 'Overview' menu). The first functionality is a set of configurable and customizable graphics that help understanding the channel behavior. The second functionality provides an assistance to RadiaLE users to evaluate the performance of their estimators. Indeed, DataAnlApp proposes a set of well-known LQEs that can be configured and evaluated based on the collected data from a given experiment. Then, DataAnlApp provides pertinent graphics to visualize the statistical properties of the LQEs under evaluation, and deduce their performances in terms of reliability and stability. Currently, DataAnlApp integrates a set of well-known LQEs (refer to Section 4.2.6). New LQEs can also be easily integrated to DataAnlApp, due to the flexibility and completeness of the collected empirical data. In particular, the performance of a newly proposed LQE can be integrated in DataAnlApp and then it can be easily compared to existing LQEs enabling an effective and fast validation.

4.2.6. Link quality estimators

A short description of six LQEs already integrated in RadiaLE is given next:

- PRR (Packet Reception Ratio) is a receiver-side estimator, computed as the ratio of the number of successfully received packets to the number of transmitted packets, for each window of w received packets.
- RNP (Required Number of Packet retransmissions) [4] is a sender-side estimator. It counts the average number of packet retransmissions required before a successful

reception. It is computed as the number of transmitted and retransmitted packets divided by the number of successfully received packets; minus 1 (to exclude the first packet transmission). This metric is evaluated at the sender side for each w packets.

- WMEWMA Window Mean Exponentially (Weighted Moving Average) [3] is a receiver-side estimator that applies filtering on PRR to smooth it, thus providing a metric that resists to transient fluctuation of PRRs, yet is responsive to major link quality changes. WMEWMA is then given by the following:

$$WMEWMA(\alpha, w) = \alpha \times WMEWMA + (1 - \alpha) \times PRR, \quad (1)$$

where $\alpha \in [0-1]$ controls the smoothness.

- ETX (Expected Transmission Count) [2] is a receiver-side estimator that approximates the packet retransmissions count, including the first transmission. It is computed as the inverse of the product of PRR of the forward link ($PRR_{forward}$) and the PRR of the backward link ($PRR_{backward}$), which takes into account link asymmetry property.

$$ETX(w) = \frac{1}{PRR_{forward} \times PRR_{backward}}. \quad (2)$$

- four-bit [1] is a sender-side estimator (already implemented in TinyOS) that approximates the packet retransmissions count. Like ETX, four-bit considers the link asymmetry property. It combines two metrics (i) $estETX_{up}$, as the quality of the unidirectional link from sender to receiver, and (ii) $estETX_{down}$, as the quality of the unidirectional link from receiver to sender. $estETX_{up}$ is exactly the RNP metric, computed based on w_p transmitted/retransmitted data packets. $estETX_{down}$ approximates RNP as the inverse of WMEWMA, -1 ; and it is computed based on w_a received beacon packets. The combination of $estETX_{up}$ and $estETX_{down}$ is performed through the EWMA filter as follow:

$$four-bit(w_a, w_p, \alpha) = \alpha \times four-bit + (1 - \alpha) \times estETX. \quad (3)$$

$estETX$ corresponds to $estETX_{up}$ or $estETX_{down}$: at w_a received beacons, the node derives $four-bit$ estimate by replacing

$estETX$ in Eq. (3) for $estETX_{down}$. At w_p transmitted/retransmitted data packets, the node derives $four-bit$ estimate by replacing $estETX$ in Eq. (3) for $estETX_{up}$.

- F-LQE (Fuzzy Link Quality Estimator) [5] is a recently proposed receiver-side estimator, where link quality is expressed as a fuzzy logic rule, which combines desirable link properties, namely the Smoothed Packet Reception Ratio (SPRR),² link stability factor (SF), link asymmetry (ASL), and channel Signal to Noise Ratio (ASNR). For a particular link, the fuzzy logic interpretation of the rule gives an estimation of its quality as a membership score in the fuzzy subset of good quality links. Scores near 1/0 are synonym of good/poor quality

² SPRR is exactly the WMEWMA[26].

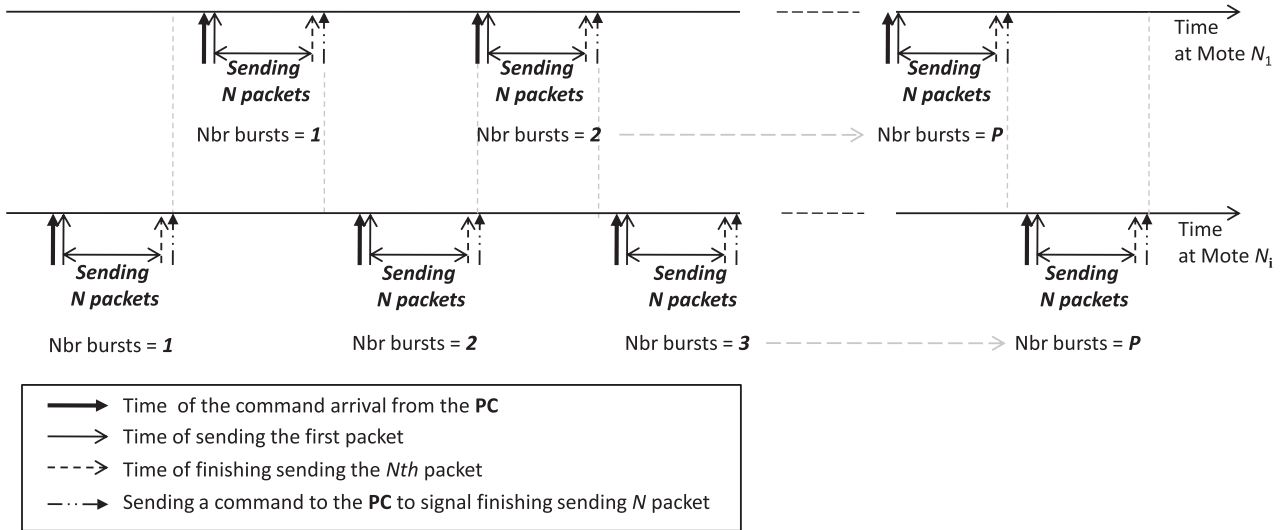

(a) $Burst(N, IPI, P)$ traffic. After receiving the command from the PC, the mote sends a burst of N packets to the other mote, with an inter-packet interval equal to IPI seconds. This operation is repeated until reaching a total number of sent bursts equal to P

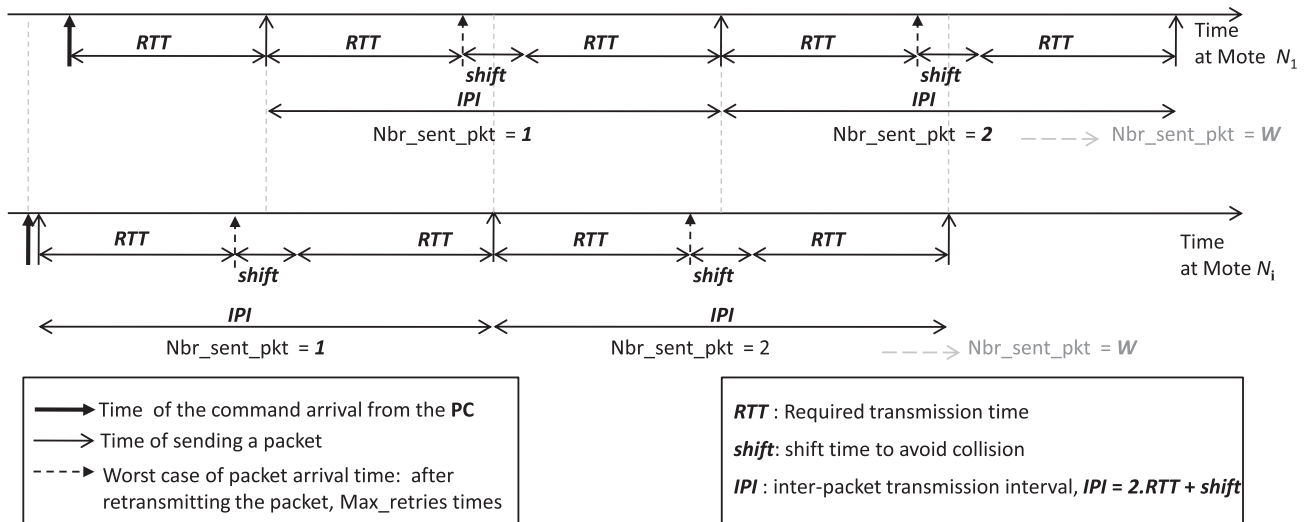

(b) $Synch(W, IPI)$ Traffic. After receiving the command from the PC, the mote sends a packet to the other mote each IPI seconds, until reaching a total number of sent packets equal to W

Fig. 3. Interaction between mote N_1 , mote N_i and the PC, allowing for a bursty or synchronized traffic exchange between the two Motes. When N_1 and N_i finish their transmission, the PC triggers a new bursty or synchronized traffic exchange between N_1 and N_{i+1} .

links. Hence, according to F-LQE, the membership of a link in the fuzzy subset of good quality links is given by the following equation:

$$\mu(i) = \beta \cdot \min(\mu_{SPRR}(i), \mu_{ASL}(i), \mu_{SF}(i), \mu_{ASNR}(i)) + (1 - \beta) \cdot \text{mean}(\mu_{SPRR}(i), \mu_{ASL}(i), \mu_{SF}(i), \mu_{ASNR}(i)). \quad (4)$$

The parameter β is a constant in $[0-1]$. μ_{SPRR} , μ_{ASL} , μ_{SF} , and μ_{ASNR} represent membership functions in the fuzzy subsets of high packet reception ratio, low asymmetry, low stability, and high channel quality, respectively. All membership functions have piecewise linear forms, determined by two thresholds. In order to get stable link estimates, F-LQE uses the EWMA filter to smooth $\mu(i)$ values. F-LQE metric is finally given by:

$$FLQE(\alpha, w) = \alpha \cdot FLQE + (1 - \alpha) \cdot 100 \cdot \mu(i), \quad (5)$$

where, $\alpha \in [0-1]$ controls the smoothness and w is the estimation window. F-LQE attributes a score to the link,

ranging in $[0-100]$, where 100 is the best link quality and 0 is the worst.

5. Experimental studies using RadiaLE

In this section, we illustrate the usefulness of RadiaLE through two case studies: the characterization of low-power links and the performance evaluation of LQEs.

5.1. Experiments description

In our experiments, we have deployed a single-hop network with 49 TelosB motes distributed according to the radial topology shown in Fig. 1, where x varies in $\{2, 3\}$ m and y is equal to 0.75 m. Fig. 4 shows the topology layout of the 49 motes at an outdoor environment (garden in ISEP, Porto). Note that x and y were pre-determined through several experiments, prior to deployment. In each

experiment, we set x and y to arbitrary values. At the end of the experiment, we measured the average PRR for each link. The chosen x and y are retained if the average PRR, with respect to each link, is between 90% and 10%. This means that the underlying links have moderate connectivity and therefore belong to the *transitional* region. Indeed, in the literature (e.g. [4,27]), the transitional region is a connectivity region that can be identified by analyzing the average PRR of the link. Note that the average PRR of a given link is the average over different PRR samples. Each PRR sample is computed based on w received packets, where w is the estimation window. As we have mentioned before (in Section 3.1), the transitional region is the most relevant context to assess the performance of LQEs.

Using ExpCtrApp software, we performed extensive experimentations through different sets of experiments. In each experiments set, we varied a certain parameter to study its impact, and the experiment was repeated for each parameter modification. Parameters under-consideration were traffic type (three sorts of bursty traffic and 1 synchronized traffic), packet size (28/114 bytes), radio channel (20/26), and maximum retransmissions count (0/6). The duration of each experiment was approximately 8 hours. Table 1 depicts the different settings for each experiments set. The transmission power was set to the (-25 dBm) in order to reach the transitional region (i.e. have all links with moderate connectivity) at shorter distances. At the end of the experiments we used DataAnlApp, the RadiaLE data analysis tool, to process packets-statistics retrieved from each bidirectional link $N_1 \leftrightarrow N_i$ and stored in a database.

In what follows, we present two studies that have been conducted using DataAnlApp. In the first study, we present results that describe important aspects of low-power links. In the second study, we conduct a comparative study of the performances of six LQEs, already supported by RadiaLE, namely PRR, WMEWMA, ETX, RNP, four-bit and F-LQE.

5.2. Characterization of low-power links

There have been several empirical studies that have analyzed the characteristics of low-power links in WSNs [4,13,19,21,28–33]. In this section, we show the potential of RadiaLE to efficiently and easily perform such empirical

studies, and produces results that confirm the characteristics of low-power links in WSNs. Experiment settings in this section correspond to Scenario 1, and Scenario 4 in Table 1.

It has been proven that the transmission range in WSNs consists of three regions: (i) connected, where links are of good quality, stable, and symmetric (ii) transitional, where links are of moderate quality (in long-term assessment), instable, uncorrelated to distance, and often asymmetric, (iii) disconnected, where links have poor quality and are not adequate for communication. Links in the connected region are easy to assess; and the challenge of LQEs is to accurately estimate the quality of links in the transitional and disconnected regions.

In our experiments, we are interested in understanding the characteristics of links that are located in the transitional region, namely the spatial and temporal characteristics as well as links asymmetry. We considered different metrics for assessing these characteristics, including PRR, RSSI, and LQI. The advantage of using RadiaLE is that it automates the visualization of such results in a user-friendly fashion.

5.2.1. Spatial behavior

At the transitional and disconnected regions, link quality is decorrelated from distance, as shown in Fig. 5. In fact, according to our radial topology, we have six receivers at different distances from N_1 . At each receiver, we compute link quality (PRR, average LQI, and average RSSI) where the averaging window is equal to 200 packets. From Fig. 5, we can see how two receivers placed at the same distance from the sender can have different link qualities, and a receiver that is farther from the sender can have better link quality than another receiver nearer to the sender.

5.2.2. Temporal behavior

Links of moderate quality, which are typically those of the transitional region, are unstable. Links instability results from many factors related to the environment and also to the nature of low-power radios, which have been shown very prone to noise. Fig. 6 shows the temporal behavior of a link of moderate quality (in long-term



Fig. 4. Nodes distribution according the radial topology, at an outdoor environment (circles were added to the picture to identify nodes positions).

Table 1

Experiment scenarios. Burst(N, IPI, P) and Synch(W, IPI); N : number of packets per burst, IPI : inter-packets interval (in ms), P : number of bursts, W : total number of packets.

	Traffic type	Pkt size (bytes)	Channel	Rtx count
Scenario 1: Impact of traffic	{Burst(100,100,10), Burst(200,500,4), Burst(100,1000,2), Synch(200,1000)}	28	26	6
Scenario 2: Impact of Pkt size	Burst(100,100,10)	{28,114}	26	6
Scenario 3: Impact of channel	Burst(100,100,10)	28	{20,26}	6
Scenario 4: Impact of Rtx count	Burst(100,100,10)	28	26	{0,6}
Scenario 5: Default settings	Burst(100,100,10)	28	26	6

assessment). This link is unstable as its quality varies drastically in time, i.e., PRR varies between 0% and 100%.

5.2.3. Link symmetry

The link symmetry level is the difference in connectivity between the uplink and the downlink. It is often quantified by the difference between the PRR of the forward link (PRR_{out}) and the PRR of the backward link (PRR_{in}). A link is considered asymmetric when the difference between PRR_{in} and PRR_{out} is greater than a certain threshold, say 40% [13]. Links in the transitional region are often asymmetric.

Link asymmetry has a great impact on the performance of higher layer protocols. Thus, it is important to accurately assess this property in order to design efficient LQEs. The assessment of the link symmetry level requires bidirectional traffic over the link, allowing the derivation of PRR_{in} and PRR_{out} . As links can be very unstable, PRR_{in} and PRR_{out} have to be computed at the same time or at least at near

times. For that reason, RadiaLE provides the synchronized traffic pattern. Bursty traffic can also provide fair measures of the link symmetry level, when using a small IPI (for sending the burst of packets). For high IPI, PRR_{in} and PRR_{out} will be computed at significantly different times, which leads to inaccurate link symmetry level assessment. Therefore, one of the important features of RadiaLE is to allow an accurate assessment of links symmetry level, using the synchronized traffic pattern and also the burst traffic pattern, provided that it is configured with small IPI. These results can be easily proven by the RadiaLE software tool through the automatic generation of plots, as depicted in Fig. 7.

Fig. 7 illustrates the impact of the traffic pattern on the link symmetry level assessment, through the computation of the empirical Cumulative Distribution Function (CDF) of the link symmetry level, for both bursty and synchronized traffic, and also for different Inter-Packets Intervals (IPIs). The CDF has been computed based on all the links in the network. Fig. 7a shows that the number of asymmetric links for a given IPI (equal to 1s) is greater than the number of asymmetric links for another IPI smaller than the first (equal to 0.5s), as it has been shown in [21]. On the other hand, Fig. 7b shows that, given the same IPI (equals to 1s), the number of asymmetric links for the bursty traffic is greater than the number of asymmetric links for the synchronized traffic.

5.3. Performance evaluation of link quality estimators

In this section, we present a comparative experimental study of the performances of six LQEs: PRR, WMEWMA, ETX, RNP, four-bit and F-LQE. As already mentioned in Section 3, the performance evaluation of LQEs is carried out by considering two performance criteria: Reliability and Stability.

Recall that there is no real link quality metric of reference, which other link quality estimators can be compared to. Therefore, we mutually compare the empirical behaviors of LQEs under study and characterize their stochastic performance by means of statistical analysis of empirical data. Note that the use of a radial topology (as presented in Fig. 1) allows to draw general and consistent conclusions

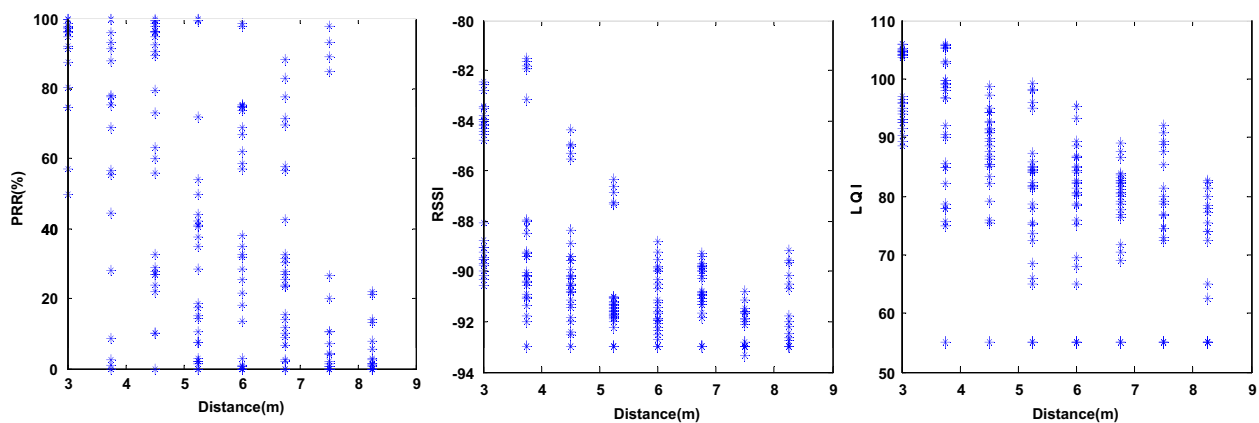

Fig. 5. Spatial behavior. Two receivers placed at the same distance from the sender may have different link qualities. Moreover, a receiver that is farther from the sender can have better link quality than another receiver nearer to the sender (refer to Table 1—Scenario 4).

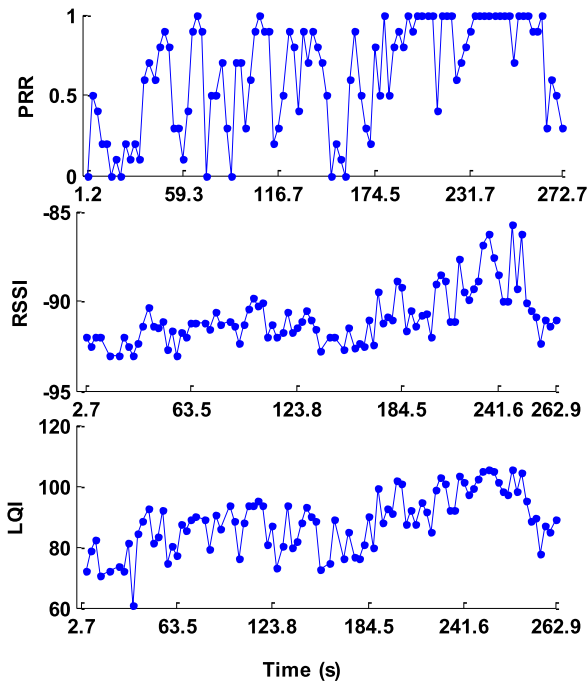

Fig. 6. Temporal behavior of a link of moderate quality in long-term assessment. This link is unstable as it shows quality fluctuation over time (refer to Table 1–Scenario 4).

about the performance of LQEs, in addition to the large empirical samples used for the statistical analysis (refer to Section 5.1). The proposal of an estimation theory for comparing LQEs of different types is outside the scope of this paper.

Recall that experimental scenarios are given in Table 1. As for the topology layout, we employed the Radial topology illustrated in Fig. 1, where x varies in the set $\{2,3\}$ m and y is equal to 0.75 m. We collected empirical data from the 48 links of our Radial topology and we repeated the experiments twice; for $x = 2$ and $x = 3$. In total, we obtained empirical data from $48 * 2 = 96$ bidirectional links. We have considered all these links to conduct our statistical analysis study, namely the empirical CDF and the CV with

respect to each LQE (e.g., in Figs. 8 and 11). Considering all these links together is important for the following reasons: (i) it improves the accuracy of our statistical analysis by considering a large sample set and (ii) it avoids having the statistical analysis being biased by several factors such as distance and direction, which provides a global understanding of LQEs behavior. In contrast, regarding the evolution of LQEs in space (e.g., in Fig. 9) or in time (e.g., in Fig. 10), the observation is made for a particular representative link, because considering all links is not relevant as it was the case with the CDF and CV.

5.3.1. Reliability

Fig. 8 presents the global empirical CDFs of all LQEs. This figure shows that PRR, WMEWMA, and ETX, which are PRR-based LQEs, overestimate the link quality. For instance, this figure shows that almost 80% of links in the network have a PRR and WMEWMA greater than 84% (which is considered a high quality value). Also 75% of the links have ETX equal to 1, (i.e. 0 retransmissions, which also means high quality). The reason of this overestimation is the fact that PRR-based LQEs are only able to evaluate the link delivery, and they are not aware of the number of retransmissions made to deliver a packet. A packet that is received after one retransmission or after n retransmissions will produce the same estimate. On the other hand, Fig. 8 shows that four-bit and RNP, which are RNP-based, underestimate the link quality. In fact Fig. 8 shows that almost 90% of the links have RNP equal to 4 retransmissions (maximum value for RNP), which means that the link is of very bad quality. We observe that Four-bit provides a more balanced characterization of the link quality than RNP, since its computation also accounts for PRR. This underestimation of RNP and four-bit is due to the fact that they are not able to determine if these packets are received after these retransmissions or not. This discrepancy between PRR-based and RNP-based link quality estimates is justified by the fact that most of the packets transmitted over the link are correctly received (high PRR) but after a certain number of retransmissions (high RNP). More importantly,

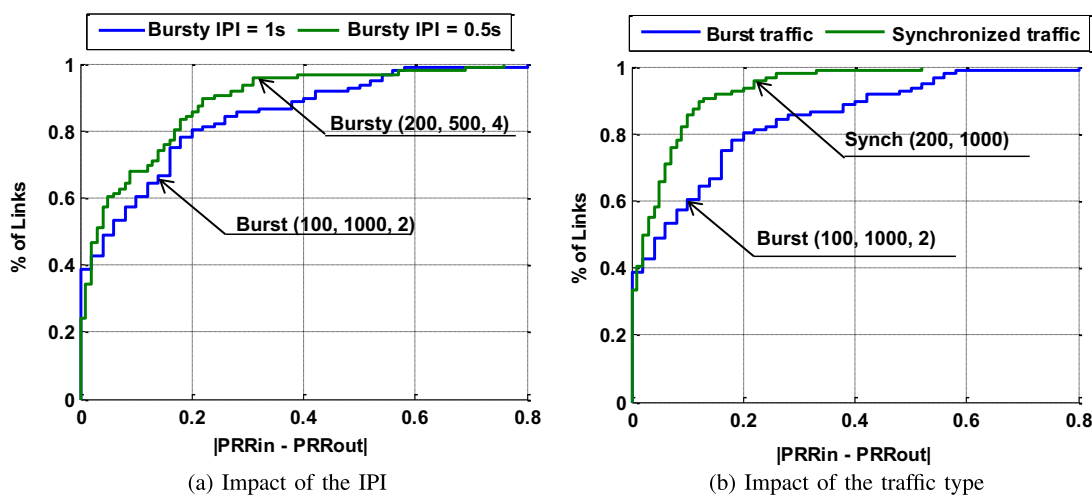

Fig. 7. CDF of the link symmetry level, for different traffic patterns. Synchronized traffic is the most appropriate pattern for the link symmetry level assessment. Bursty traffic can be used for the link symmetry level assessment but with small IPI (refer to Table 1–Scenario 1).

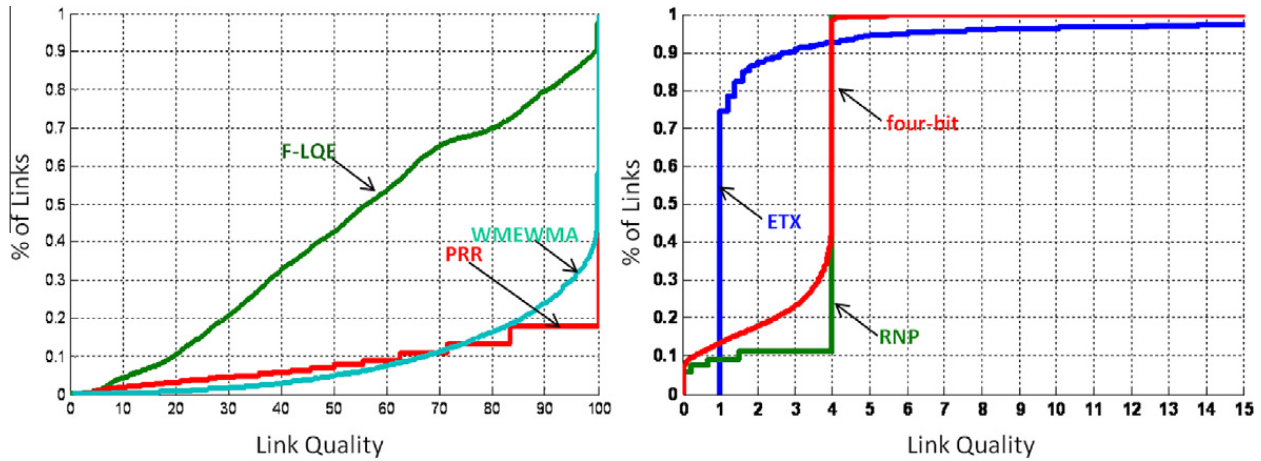

Fig. 8. Empirical CDFs of LQEs, based on all the links in the network (refer to Table 1–Scenario 5).

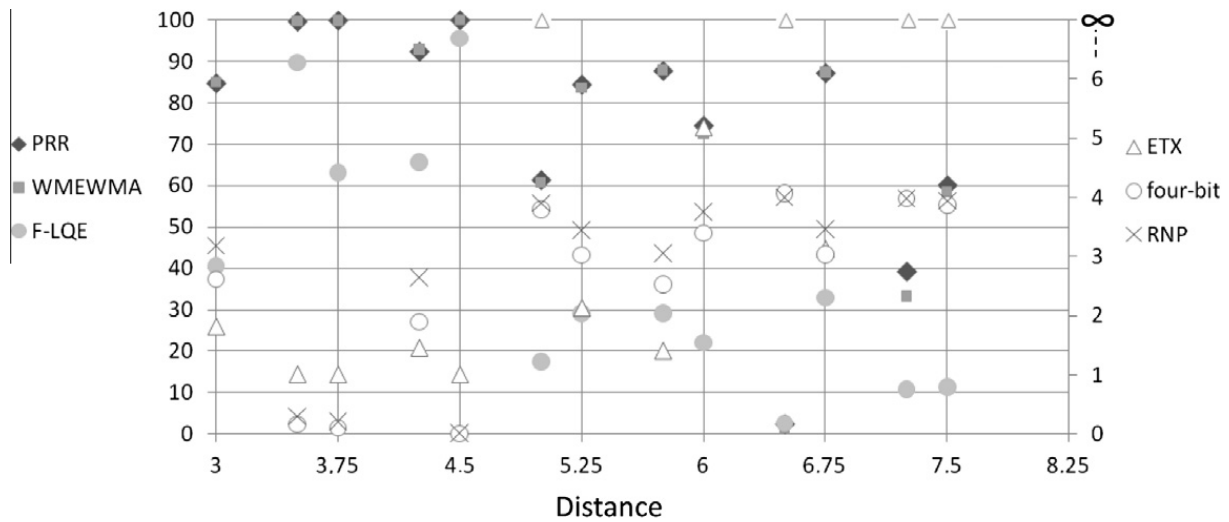

Fig. 9. Scatter plot of each LQE according to distance (refer to Table 1–Scenario 5). Note we subtract 1 from ETX, to account only for the retransmitted packets.

each of these LQEs assess a single and different link property (either packet reception or number of packet retransmission). As for F-LQE, Fig. 8 shows that the distribution of link quality estimates is nearly an uniform distribution, which means that F-LQE is able to distinguish between links having different link qualities. In other words, F-LQE neither overestimates the link quality like PRR-based estimators do, nor underestimates it like RNP-based estimators do. This is because it takes into account different properties of radio links, namely Reception Ratio, stability, asymmetry, and channel quality, in order to provide a global characterization of the real link state.

These observations are confirmed by Figs. 9 and 10. Fig. 9 illustrates the difference in decisions made by LQEs in assessing link quality. For instance, at a distance of 6 m, PRR and WMEWMA assess the link to have moderate quality (74% and 72% respectively), whereas RNP and four-bit assess the link to have poor quality (around 3.76 retransmissions). At a distance of 6 m, ETX is PRR-based, but in contrary to other PRR-based LQEs, it assesses the link to have poor quality (five retransmissions). The reason

is that the PRR in the other direction is low (refer to Eq. (2)). Fig. 9 shows also that F-LQE estimates are more scattered than those of the other link estimators, which means that F-LQE is able to provide a fine grain classification of links comparing to the other LQEs.

PRR, WMEWMA, ETX and F-LQE are computed at the receiver side, whereas RNP and four-bit are computed at the sender side. When the link is of a bad quality, the case of the link in Fig. 10b, packets are retransmitted many times without being able to be delivered to the receiver. Consequently, receiver-side LQEs can not be updated and they are not responsive to link quality degradation. On the other hand, sender-side LQEs are more responsive. This observation can be clearly understood from Fig. 10b.

In summary, traditional LQEs, including PRR, WMEWMA, ETX, RNP and four-bit were shown not sufficiently reliable, as they either overestimate or underestimate link quality. On the other hand, F-LQE, a more recent LQE was shown more reliable as it provides a fine grain classification of links. However, F-LQE as well as PRR, WMEWMA and ETX are not responsive to link quality degradation

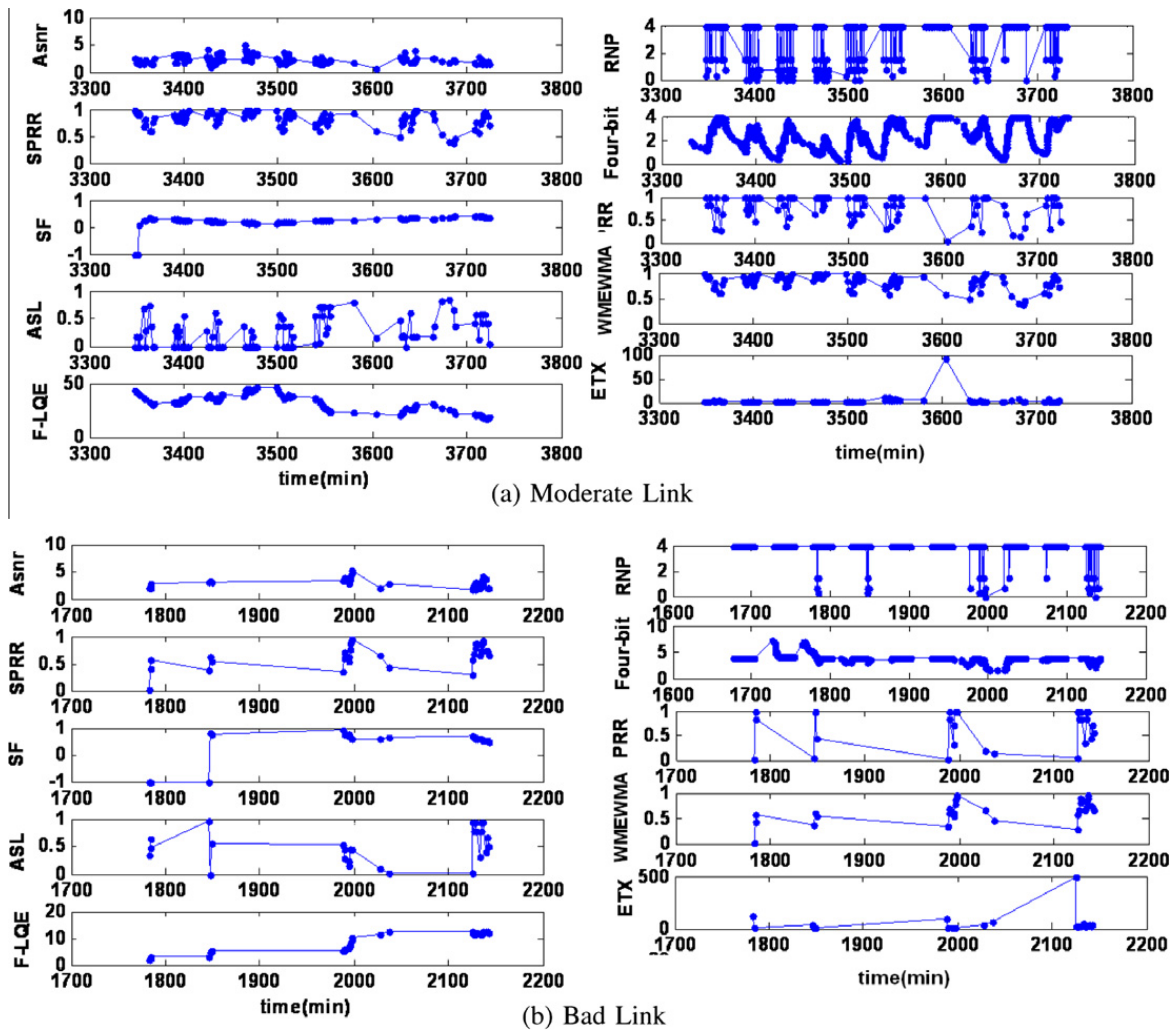

Fig. 10. Temporal behavior of LQEs when faced with links with different qualities. The left figure shows the temporal behavior of F-LQE and the four metrics that it integrates (ASNR, SPRR, SF and ASL). The right figure shows the temporal behavior of the other estimators (RNP, Four-bit, PRR, WMEWMA and ETX). (refer to Table 1—Scenario 5).

because they are receiver-side LQEs. RNP and four-bit are more responsive as they are computed at the sender side.

5.3.2. Stability

A link may show transient link quality fluctuations (Fig. 10) due to many factors mainly related to the environment, and also to the nature of low-power radios, which have been shown to be very prone to noise. LQEs should be robust against these fluctuations and provide stable link quality estimates. This property is of a paramount importance in WSNs. For instance, routing protocols do not have to recompute information when a link quality shows transient degradation, because rerouting is a very energy and time consuming operation.

To reason about this issue, we measured the sensitivity of the LQEs to transient fluctuations through the coefficient of variation of its estimates. Fig. 11 compares the sensitivity (stability) of LQEs with respect to different settings (refer to Table 1). According to this figure, we retain the following observations. First, generally, F-LQE is the most stable LQE. Second, WMEWMA is more stable than PRR and four-bit is more stable than RNP. The reason is that

WMEWMA and four-bit use filtering to smooth PRR and RNP respectively. Third, except ETX, PRR-based LQEs, i.e. PRR and WMEWMA, are generally more stable than RNP-based LQEs, i.e. RNP and four-bit. ETX is PRR-based, yet it is shown as unstable. The reason is that when the PRR tends to 0 (very bad link) the ETX will tend to infinity, which increases the standard deviation of ETX link estimates.

6. TOSSIM 2 channel model

TOSSIM 2 is an event-driven simulator for WSNs (simulates MICAz motes), developed under TinyOS 2.x [34] environment. It has been argued that TOSSIM 2 provides an accurate wireless channel model [35,36]. Several previous studies validate their solutions using TOSSIM 2 simulations. Particularly, in [37], the authors conducted a comparative study of a set of LQEs using TOSSIM 2 and simulation results have been claimed as valid based on the assumption that TOSSIM 2 features a realistic channel model.

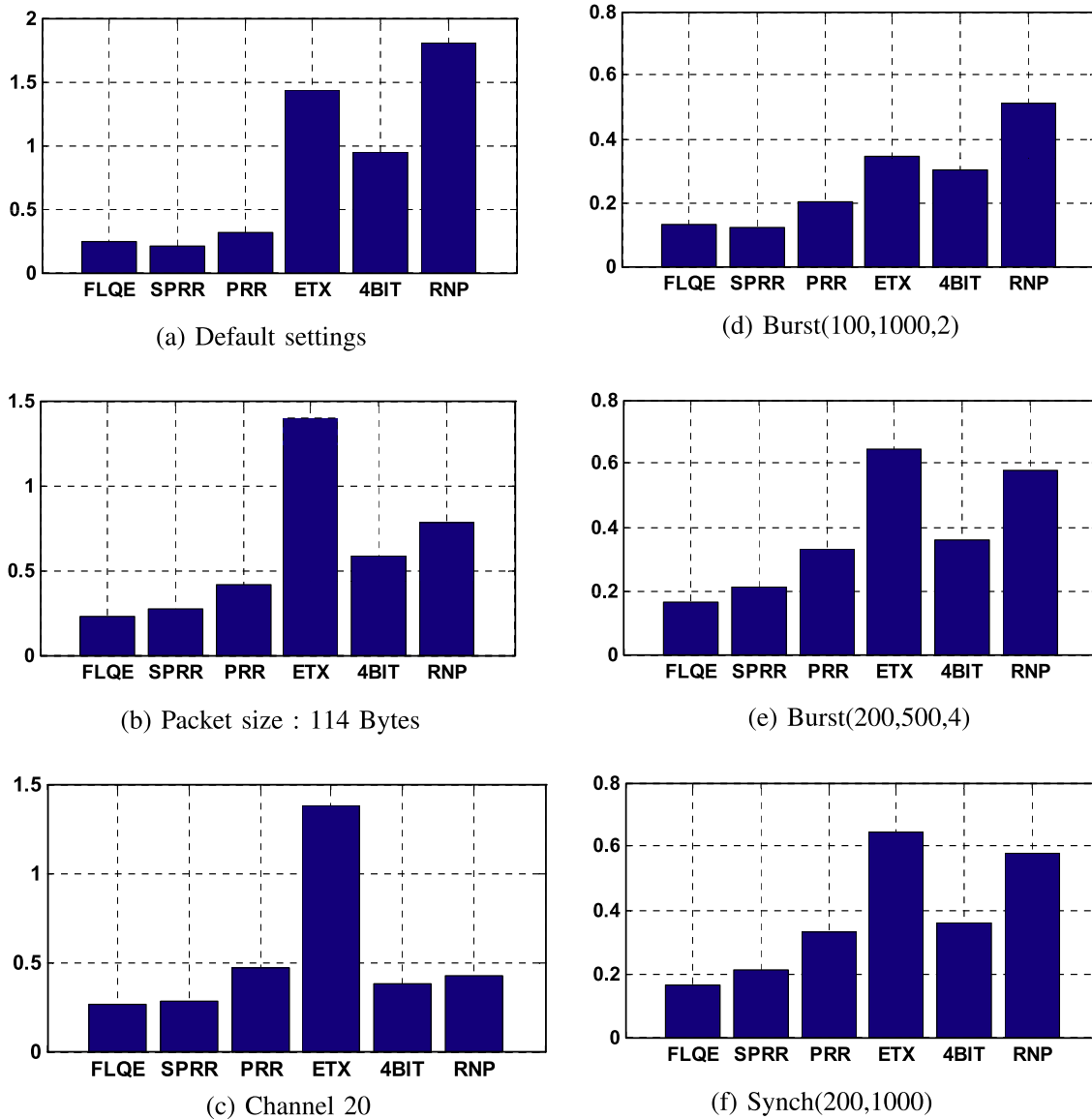

Fig. 11. Stability of LQEs, for different network settings. Stability is assessed by the coefficient of variation (CV) of link quality estimates, with respect to each LQE. Lower values means more stable LQE. (refer to Table 1—Scenarios 1, 2, . . . , 5).

In this section, we propose to assess the reliability of TOSSIM 2 channel model. To achieve this goal, we evaluate the performance of LQEs under-consideration, namely PRR, WMEWMA, ETX, RNP, four-bit and F-LQE, based on TOSSIM 2 simulations. The performance evaluation is carried out by testing the reliability and stability of LQEs, through the analysis of their statistical properties. Then, we compare the simulation-based results against the experimental-based results reported in the previous section.

It is important to note that TOSSIM 2 simulates only MicaZ motes, which are based on the CC2420 chip. Thus, with this current limitation of TOSSIM 2 it will not be possible to validate the channel model of TOSSIM 2 if other radio chips are used in the experimental study with RadiaLE. Nevertheless, it is conceivable to extend the Physical Layer Model of TOSSIM to support other radio chips, and in this case an experimental-based validation will be possible.

6.1. Overview of the TOSSIM 2 channel model

In this section, we present a short overview of TOSSIM 2 channel model. The interested readers can refer to [35,36] for more details on this wireless channel model. Basically, the wireless channel model of TOSSIM 2 relies on the *Link layer model* [36] and the *Closest-fit Pattern Matching (CPM)* model [35].

The link layer model of Zuniga et al. [36] corresponds to an analytical model of the PRR according to distance: $PRR(d)$. For non-coherent FSK modulation and Manchester encoding (used by MICAZ motes), this model is given by the following expression:

$$PRR(d) = \left(1 - \frac{1}{2} \cdot \exp\left(-\frac{SNR(d)}{2} \cdot \frac{B_N}{R}\right) \right)^{8L}, \quad (6)$$

where B_N is the noise bandwidth, R is the data rate in bits, and L is the packet size. These parameters are set to default values.

The $SNR(d)$ is given by:

$$SNR(d) = RSS(d) - P_n. \quad (7)$$

- $RSS(d)$ is the pure (i.e, without noise) received signal strength in dB as a function of distance. It is computed as: $P_t - PathLoss(d)$, where P_t is the transmission power

in dB and $PathLoss(d)$ is the path loss in dB as a function of distance. $PathLoss(d)$ corresponds to the *log-normal shadowing* path loss model [36,38].

- P_n is the sampled noise floor in dB. TOSSIM 2 relies on the CPM model [35] to generate noise floor samples for a given link, which captures the temporal variation of the channel. The principal inputs of this model are the average noise floor at the receiver ($\overline{P_n}$) the noise floor variance, and a noise trace file containing 100 readings.

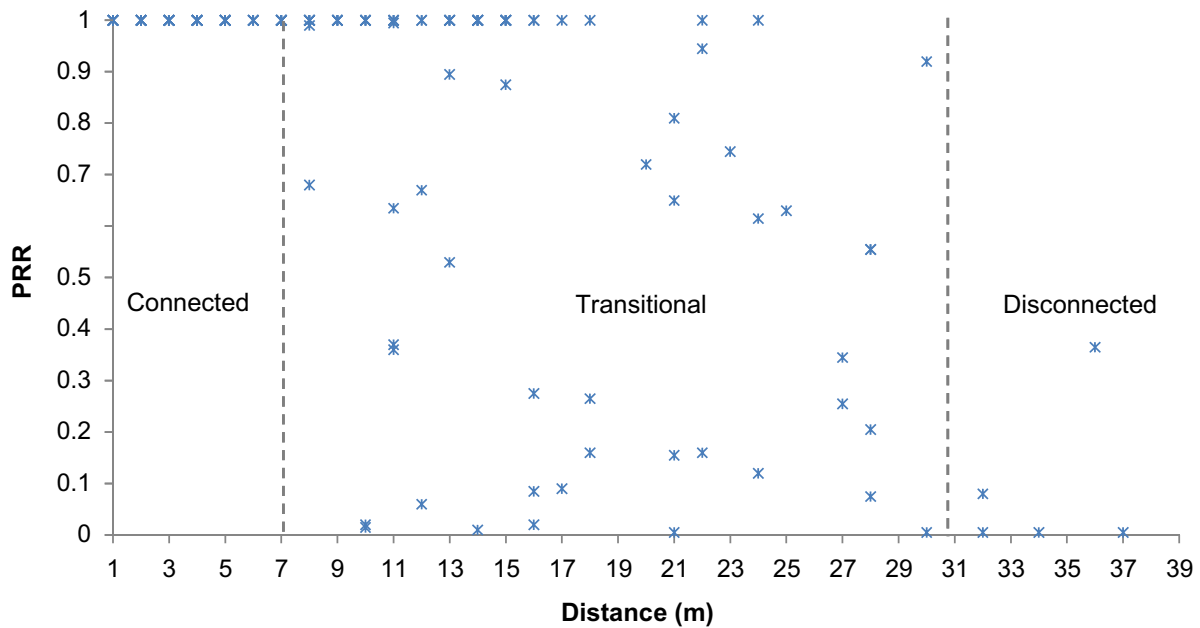

(a) Indoor environment: aisle of building [39]

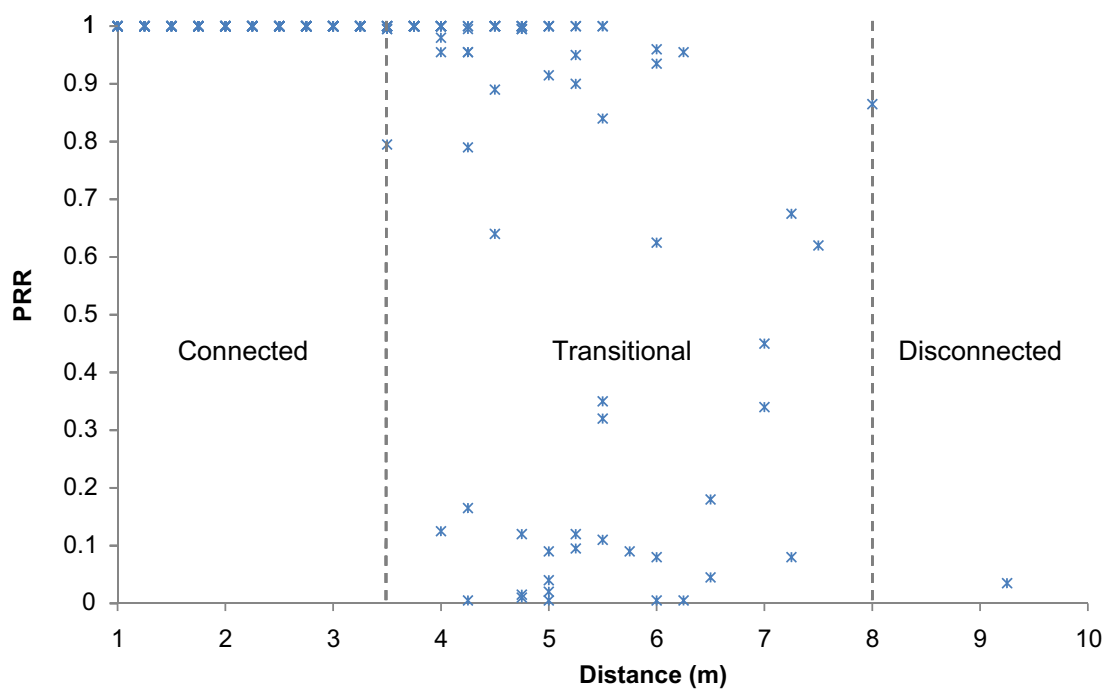

(b) Outdoor environment: football field [39]

Fig. 12. Illustration of TOSSIM 2 channel model reliability: the three reception regions.

An important feature of the link layer model is the fact that it takes into account the hardware variance, i.e. the variability of the transmission power among different senders and the variability of the noise floor among different receivers. The hardware variance is the main cause of link asymmetry [13,30,36]. To model this variance, the transmission power and the noise floor are considered as Gaussian random variables. Given the variances of the noise floor and the transmission power respectively, the link layer model generates two Gaussian distributions for each variable. Thus, it assigns a transmission power P_t to each simulated sender and a noise floor \bar{P}_n , to each simulated receiver. For a given link, P_t is constant over time and \bar{P}_n is used to generate different noise floor readings (i.e. different P_n s) to capture the link dynamism.

Now, let's see how TOSSIM 2 uses the channel model presented above: At the beginning of the simulation and based on the channel and radio parameters as well as the topology specification, determined by the user, TOSSIM 2 generates the RSS, and the \bar{P}_n for each link (sender → receiver). TOSSIM 2 models packet reception over a link as a Bernoulli trial with probability equal to PRR. When a packet is received, a simulated receiver samples a noise floor reading (P_n) using the CPM model and computes the PRR according the link layer model (Eq. (4)).

6.2. Advantages and shortcomings of TOSSIM 2 channel model

The TOSSIM 2 channel model has the advantage of capturing important low-power links characteristics, namely spatial and temporal characteristics, as well as the asymmetry property. For instance, spatial characteristics are captured by modeling the three reception regions: connected, transitional and disconnected, using the link layer model [36]. To illustrate this fact, we conducted extensive simulations for two environment settings and plotted the PRR as a function of distance, as shown in Fig. 12. From this figure, it is possible to observe the three reception regions (obtained by TOSSIM 2 simulation), which are similar to those observed with real measurements in [13].

On the other hand, TOSSIM 2 presents some shortcomings that result from some assumptions. Indeed, TOSSIM 2 uses the log-normal shadowing model to model the path loss. This model has been shown to provide an accurate

multi-path channel model. However, it does not take into account the anisotropy property of the radio range, i.e. attenuation of the signal according to the receiver's direction. Therefore, TOSSIM 2 assumes that link quality does not vary according to direction, despite it models the variation according to distance.

Another assumption made by TOSSIM 2 is the fact that $RSS(d)$, which concerns a given link having a distance d , is constant over time. This assumption is justified by the fact that the link layer model is designed for static environments [36]. Nevertheless, the “real” received signal strength, which is the $RSS(d)$ added to the noise floor ($RSS + P_n$), varies according to time because TOSSIM 2 takes into account the variability of P_n over time using the CPM model [35]. Therefore, link quality (e.g. RSSI, PRR, SNR) varies over time (for a given link), which captures the link temporal behavior.

6.3. Testing the reliability of TOSSIM 2 channel model

In this section, we assess the reliability of the TOSSIM 2 channel model by reproducing the experimental study conducted with RadiaLE, using TOSSIM 2 simulation; and comparing the experimental results with the simulation results.

To establish a rich set of links having different qualities, we considered the following scenario: a single-hop network of 10 sensor nodes (N_1, N_2, \dots, N_{10}) placed in a linear topology (a line from the radial topology). Recall that TOSSIM 2 assumes that link quality does not vary according to direction. Therefore, it would be useless to consider the radial topology in this simulation study. The distance between N_i and N_{i+1} , where i in $[2-9]$, is fixed to 1 m, whereas the distance between N_1 and N_2 is variable; let's note by x . We used bursty traffic, specified as follows: Node N_1 sends a first burst of 400 packets to N_i , then the node N_i sends a burst of 100 packets to N_1 . The total number of bursts for each node is equal to 6 and the IPI is equal to 720 ms. The simulated network is configured as an Indoor environment [39]. The above described scenario is simulated 10 times while varying the x parameter. Thus, the underlying links $N_1 \leftrightarrow N_i$ exhibit different link qualities.

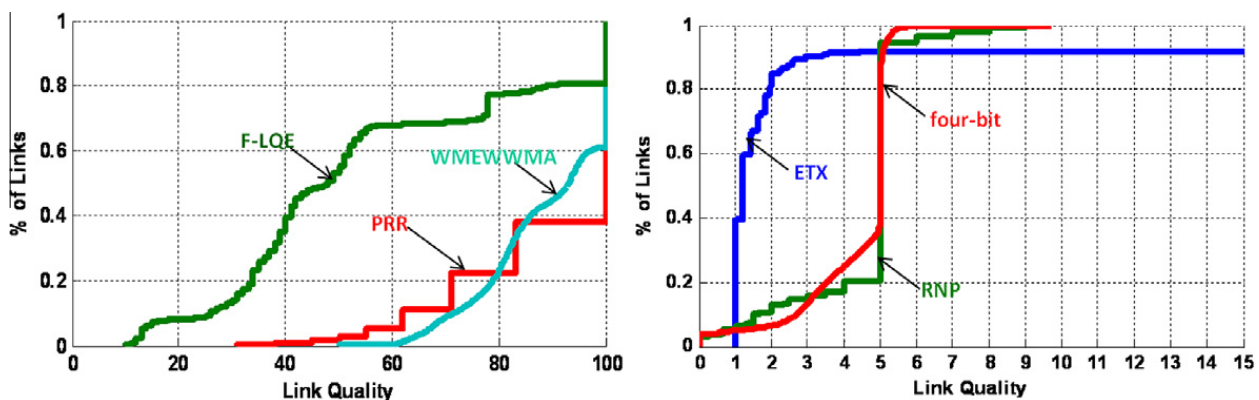

Fig. 13. Empirical CDFs of LQEs, based on all the links in the simulated network (Tossim 2 simulation results, refer to Fig. 8 for comparison).

In the following, we present the simulation results for the performance comparison of PRR, WMEWMA, ETX, RNP, and four-bit, in terms of reliability and stability.

6.3.1. Reliability

It can be clearly observed that the empirical CDF of LQEs, computed based on all links in the simulated networks and illustrated in Fig. 13, has the same shape as the empirical CDF of LQEs computed based on real experiments (Fig. 8).

Consequently, it can be confirmed, based on these simulation results, that PRR, WMEWMA, and ETX overestimate the link quality. RNP and four-bit underestimate the link quality. On the other hand, F-LQE has a uniform distribution. Moreover, RNP and four-bit are computed at the sender side and are more responsive to link quality degradations. This fact can also be observed from the temporal behavior depicted in Fig. 14.

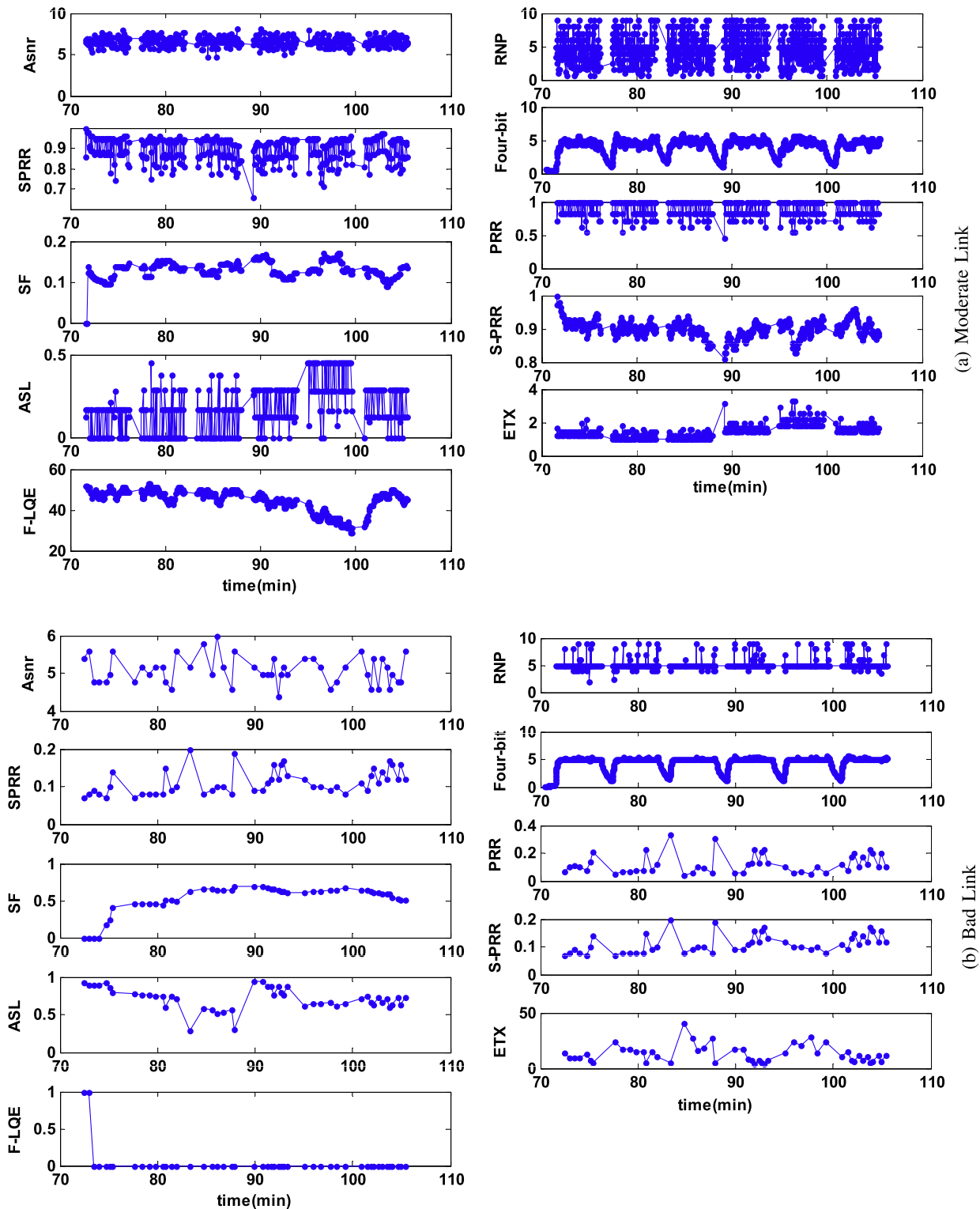

Fig. 14. Temporal behavior of LQEs when faced with links with different qualities (Tossim 2 simulation results, refer to Fig. 10 for comparison).

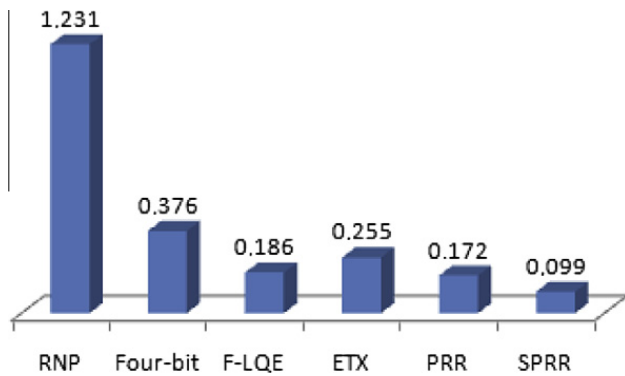

Fig. 15. Stability of LQEs (Tossim 2 simulation results, refer to Fig. 11 for comparison).

6.3.2. Stability

Fig. 15 shows that RNP and four-bit are more instable than PRR, WMAWMA and F-LQE, as they are more responsive to link quality fluctuations. This finding confirms the results found in the experimental study (Fig. 11). However, ETX is shown to be much more instable in the experimental study than in simulation. The instability of ETX in the experimental study is due to the presence of very low PRRs (in the range of 10^{-3}). On the other hand, in simulation, PRR rarely takes low values. This should be due to the assumption that packet reception is a Bernoulli trial, and also to the non-ideality of random number generators. Nevertheless, it is well-known that simulation can not provide very accurate models, as very accurate models will be at the cost of high complexity and poor scalability.

In summary, we can argue that TOSSIM 2 channel model provides a reasonable tradeoff between accuracy and simplicity. Nevertheless, recall that despite TOSSIM 2 channel model captures important link properties, including spatial and temporal behaviors, and link asymmetry, it does not take into account the variation of the RSS according to the direction. In addition, TOSSIM 2 channel model assumes a static environment. Consequently, the RSS is constant with time. What makes the channel variability is only the noise floor variation. While these simplifications did not have a great impact on the validity of our results, the case might be different for other studies, such as those that deal with localization algorithms that estimate nodes locations based on the RSS.

7. Conclusion

This paper presented RadiaLE, a framework that automates the experimental evaluation, design and optimization of LQEs. It is available as open-source at [15]. The idea is that everyone can use it in its own location just by downloading and running RadiaLE software tool. To the best of our knowledge, RadiaLE is the first testbed dedicated to such objective. It presents several advantages compared to existing testbeds such as providing abstractions to the implementation details and the flexibility and completeness of the collected database. The current RadiaLE version integrates a set of well-known LQEs, namely ETX, four-bit, RNP, PRR and WMEWMA, as well as a new LQE, called F-LQE [5].

RadiaLE is much more than an experimental testbed. It stands for a methodology that allows researchers (i) to properly set different types of links and different types of traffic, (ii) to collect a rich database of link measurements, and (iii) to validate their solutions using a holistic and unified approach. Furthermore, RadiaLE can be used to validate the accuracy of the channel model of network simulators. It is just a matter of replaying the performed experiments using the simulator under-consideration and comparing the simulation results against the experimental results.

To demonstrate the usefulness of RadiaLE, we have conducted two case studies: the characterization of low-power links and the performance evaluation of LQEs. In the first study, we have confirmed results produced by previous empirical studies on the characterization of low-power links. Furthermore, we have investigated the importance of the traffic type on the accuracy of link measurements. In the second study, we conducted a thorough comparative study of six LQEs using a radial topology, which provided a significant variety of link qualities in the gray area. Our statistical analysis has shown that traditional LQEs, including PRR, WMEWMA, ETX, RNP and four-bit are not sufficiently reliable as they either overestimate or underestimate link quality, as the estimations get concentrated on higher or lower values. This is due to the fact that they base their estimation on a single link property, e.g. packet delivery or packet retransmission count. On the other hand, F-LQE, a more recent estimator has been found more reliable, as its estimations are distributed in an uniform way. F-LQE combines several important link properties to get a holistic characterization of the link. However, the drawback of F-LQE is the non responsiveness as it is computed at the receiver-side. Finally ETX, RNP and four-bit were found unstable, in contrary to PRR, WMEWMA and F-LQE.

We have also used the RadiaLE framework to examine the accuracy of the wireless channel model in TOSSIM 2. First, we conducted a TOSSIM 2 simulation study for the performance evaluation of the six LQEs under-consideration [15]. Then, we compared the simulation results against the experimental results obtained using RadiaLE. Overall, experimental results match the simulation results. We have shown that TOSSIM 2 channel model seems to be efficient and reliable as it provides a reasonable tradeoff between accuracy and simplicity.

The current RadiaLE version evaluates the performance of LQEs by studying their statistical properties independently of routing (it uses a single-hop network). However, link quality estimation is a fundamental building block for routing protocols to maximize the lifetime, the reliability, and the throughput of WSNs. Therefore, future work will address making RadiaLE able to analyze the impact of the LQEs under consideration on routing protocols and other mechanisms such as mobility management.

Acknowledgement

This work was funded by the ReDCAD research unit (05-UR-1403), by the Portuguese Science Foundation under the CISTER Research Unit (FCT UI 608), by the CONET European Network of Excellence and by the EMMON European project.

References

- [1] R. Fonseca, O. Gnawali, K. Jamieson, P. Levis, Four bit wireless link estimation, in: Proceedings of the Sixth Workshop on Hot Topics in Networks (HotNets VI), 2007.
- [2] D.S.J. De Couto, D. Aguayo, J. Bicket, R. Morris, A High-Throughput Path Metric for Multi-Hop Wireless Routing, ACM Press, 2003. p. 134. <<http://portal.acm.org/citation.cfm?doid=938985.939000>>.
- [3] A. Woo, D. Culler, Evaluation of efficient link reliability estimators for low-power wireless networks, EECS Department, University of California, Berkeley, Tech. rep. UCB/CSD-03-1270, 2003. <<http://www.eecs.berkeley.edu/Pubs/TechRpts/2003/6239.html>>.
- [4] A. Cerpa, J.L. Wong, M. Potkonjak, D. Estrin, Temporal Properties of Low Power Wireless Links, Modeling and Implications on Multi-Hop Routing, ACM Press, 2005. p. 414. <<http://portal.acm.org/citation.cfm?doid=1062689.1062741>>.
- [5] N. Baccour, A. Koubaa, H. Youssef, M. Ben Jamaa, D. do Rosário, M. Alves, L.B. Becker, F-lqe: a fuzzy link quality estimator for wireless sensor networks, in: 7th European Conference on Wireless Sensor Networks (EWSN 2010), LNCS, 5970, Springer, Coimbra, Portugal, 2010, pp. 240–255.
- [6] G. Omprakash, F. Rodrigo, J. Kyle, M. David, L. Philip, Collection tree protocol, in: Proceedings of the 7th ACM Conference on Embedded Networked Sensor Systems (SenSys '09), ACM, 2009, pp. 90–100.
- [7] J. Chen, R. Lin, Y. Li, Y. Sun, Lqer: a link quality estimation based routing for wireless sensor networks, *Sensors* 8 (2) (2008) 1025–1038.
- [8] G. Werner-Allen, P. Swieskowski, M. Welsh, Motelab: a wireless sensor network testbed, in: Proceedings of the Fourth International Conference on Information Processing in Sensor Networks (IPSN'05), Special Track on Platform Tools and Design Methods for Network Embedded Sensors (SPOTS), 2005.
- [9] B. Chun, P. Buonadonna, A. AuYoung, C. Ng, D. Parkes, J. Shneidman, A. Snoeren, A. Vahdat, Mirage: A Microeconomic Resource Allocation System for Sensor Network Testbeds, IEEE, 2005. pp. 19–28. <<http://ieeexplore.ieee.org/lpdocs/epic03/wrapper.htm?arnumber=1469095>>.
- [10] V. Handziski, A. Köpke, A. Willig, A. Wolisz, Twist: a scalable and reconfigurable testbed for wireless indoor experiments with sensor networks, in: Proceedings of the 2nd International Workshop Multi-Hop Ad Hoc Networks: From Theory to Reality REALMAN, May 2006.
- [11] A. Arora, E. Ertin, R. Ramnath, M. Nesterenko, W. Leal, Kansei: a high-fidelity sensing testbed, *IEEE Internet Computing* 10 (2) (2006) 35–47. <<http://ieeexplore.ieee.org/lpdocs/epic03/wrapper.htm?arnumber=1607985>>.
- [12] D. Johnson, D. Flickinger, T. Stack, R. Ricci, L. Stoller, R. Fish, K. Webb, M. Minor, J. Lepreau, Emulab's Wireless Sensor Net Testbed, True Mobility, Location Precision, and Remote Access, ACM Press, 2005. p. 306. <<http://portal.acm.org/citation.cfm?doid=1098918.1098971>>.
- [13] A. Cerpa, N. Busek, D. Estrin, Scale: a tool for simple connectivity assessment in lossy environments, Tech. rep., 2003.
- [14] K. Srinivasan, M.A. Kazandjieva, M. Jain, E. Kim, P. Levis, Swat, Enabling Wireless Network Measurements, ACM Press, 2008. p. 395. <<http://portal.acm.org/citation.cfm?doid=1460412.1460469>>.
- [15] Radiale benchmarking tool, 2010, <<http://www.open-lqe.net>>.
- [16] J. Elson, S. Bien, N. Busek, V. Bychkovskiy, A. Cerpa, D. Ganesan, L. Girod, B. Greenstein, T. Schoellhammer, T. Stathopoulos, D. Estrin, Emstar: an environment for developing wireless embedded systems software, 2003.
- [17] D. Johnson, T. Stack, R. Fish, D.M. Flickinger, L. Stoller, R. Ricci, J. Lepreau, Mobile emulab: a robotic wireless and sensor network testbed, in: INFOCOM, IEEE, 2006.
- [18] J. Beutel, M. Dyer, L. Meier, M. Ringwald, L. Thiele, Next-generation deployment support for sensor networks, in: 207. Computer Engineering and Networks Lab, Swiss Federal Institute of Technology, 2004.
- [19] K. Srinivasan, P. Levis, Rssi is under appreciated, in: Proceedings of the Third Workshop on Embedded Networked Sensors (EmNets), 2006.
- [20] Four-bit implementation. <<http://www.tinyos.net/tinyos-2.x/tos/lib/net/4bitle/>>.
- [21] K. Srinivasan, M.A. Kazandjieva, S. Agarwal, P. Levis, The beta Factor Measuring Wireless Link Burstiness, ACM Press, 2008. p. 29. <<http://portal.acm.org/citation.cfm?doid=1460412.1460416>>.
- [22] D. Gay, P. Levis, R. von Behren, M. Welsh, E. Brewer, D. Culler, The Language, A Holistic Approach to Networked Embedded Systems, ACM Press, 2003. p. 1. <<http://portal.acm.org/citation.cfm?doid=781131.781133>>.
- [23] Tinyos 2, 2009, <<http://www.tinyos.net/tinyos-2.x/tos/>>.
- [24] J. Polastre, R. Szewczyk, D. Culler, Telos: enabling ultra-low power wireless research, in: IPSN '05: Proceedings of the 4th International Symposium on Information Processing in Sensor Networks, IEEE Press, Piscataway, NJ, USA, 2005, p. 48.
- [25] Chipcon cc2420: Data sheet, 2009, <http://enaweb.eng.yale.edu/drupal/system/files/CC2420_Data_Sheet_1_%4.pdf>.
- [26] A. Woo, T. Tong, D. Culler, Taming the underlying challenges of reliable multihop routing in sensor networks, in: SenSys '03: Proceedings of the 1st International Conference on Embedded Networked Sensor Systems, ACM, New York, NY, USA, 2003, pp. 14–27.
- [27] N. Zamalloa, Marco Zú, B. Krishnamachari, Analyzing the transitional region in low power wireless links, in: IEEE SECON: First Annual IEEE Communications Society Conference on Sensor and Ad Hoc Communications and Networks, 2004, pp. 517–526.
- [28] D. Ganesan, B. Krishnamachari, A. Woo, D. Culler, D. Estrin, S. Wicker, Complex behavior at scale: An experimental study of low-power wireless sensor networks, Tech. rep., 2002.
- [29] D. Lal, A. Manjeshwar, F. Herrmann, E. Uysal-Biyikoglu, A. Keshavarzian, Measurement and characterization of link quality metrics in energy constrained wireless sensor networks, in: IEEE Global Telecommunications Conference (IEEE GLOBECOM), 2003.
- [30] J. Zhao, R. Govindan, Understanding packet delivery performance in dense wireless sensor networks, 2003, pp. 1–13.
- [31] G. Zhou, T. He, S. Krishnamurthy, J.A. Stankovic, Impact of Radio Irregularity on Wireless Sensor Networks, ACM Press, 2004. p. 125. <<http://portal.acm.org/citation.cfm?doid=990064.990081>>.
- [32] D. Son, B. Krishnamachari, J. Heidemann, Experimental Study of Concurrent Transmission in Wireless Sensor Networks, ACM Press, 2006. p. 237. <<http://portal.acm.org/citation.cfm?doid=1182807.1182831>>.
- [33] L. Tang, K.-C. Wang, Y. Huang, F. Gu, Channel characterization and link quality assessment of IEEE 802.15.4-compliant radio for factory environments, *IEEE Transactions on Industrial Information* 3 (2) (2007) 99–110.
- [34] Tinyos, <www.tinyos.net/>.
- [35] H. Lee, A. Cerpa, P. Levis, Improving Wireless Simulation Through Noise Modeling, ACM Press, 2007. p. 21. <<http://portal.acm.org/citation.cfm?doid=1236360.1236364>>.
- [36] M.Z. Zamalloa, B. Krishnamachari, An analysis of unreliability and asymmetry in low-power wireless links, *ACM Transactions on Sensor Networks* 3 (2) (2007) 7. <<http://portal.acm.org/citation.cfm?doid=1240226.1240227>>.
- [37] N. Baccour, A. Koubaa, M. Ben Jamaa, H. Youssef, M. Zuniga, M. Alves, A comparative simulation study of link quality estimators in wireless sensor networks, in: 17th IEEE/ACM International Symposium on Modelling, Analysis and Simulation of Computer and Telecommunication Systems (MASCOTS'09), 2009.
- [38] T.S. Rappaport, *Wireless Communications: Principles and Practice*, Prentice Hall, 2001.
- [39] Topology configuration, 2009, <<http://www.tinyos.net/dist-2.0.0/tinyos-2.x/doc/html/tutorial/usc-topologies.html>>.



Nouha Baccour was born in 1981. Currently, she is a research assistant at computer science department, National Engineering School of Sfax (Tunisia). She is also a Ph.D. student at the National Engineering School of Sfax since January 2007. Her research activity is conducted within ReDCAD research unit, in collaboration with CISTER research unit. In addition, she is involved in the CONET European Network of Excellence as an external collaborator, in particular with the research cluster COTS-based architecture for QoS in large-scale distributed embedded systems. She has received the Engineering degree in computer science, from the National Engineering School of Sfax in 2005 and the Master degree in Automatic and Industrial Computer Science, from the National Engineering School of Sfax, in 2006. Her current research interests are in the field of Wireless Sensor Networks (WSN). They are focused on the characterization, quality estimation, and modeling of low-power links in WSNs. Recently, Nouha Baccour and the rest of Radiale team have released a new website for open-source link quality estimators benchmarking (<http://www.open-lqe.net/>). She has several publications in reputed conferences (e.g. MASCOTS, EWSN).



Anis Koubaa was born in 1977. He received the Engineering degree in telecommunications from the Higher School of Telecommunications, Tunis, Tunisia, in 2000, and the M.Sc. and Ph.D. degrees in computer science from the National Polytechnic Institute of Lorraine (INPL), Nancy, France, in 2001 and 2004, respectively. He is currently an Assistant Professor at the College of Computer Science and Information Systems, Al-Imam Muhammad Ibn Saud University, Riyadh, Saudi Arabia, and a Research Associate at the CISTER/IPP-HURRAY

Research Group, Porto, Portugal. He is actively working on the design of large-scale wireless sensor networks and cyber-physical systems, while maintaining QoS, security, mobility and reliability. He is particularly interested in the assessment and improvement of the IEEE 802.15.4/ZigBee standard protocol stack for large-scale wireless sensor networks. He has driven the research efforts in the context of the ART-WiSe and open-ZB research frameworks that have contributed to the release of an open-source toolset of the IEEE 802.15.4/ZigBee protocol stack. He is the Chair of the TinyOS ZigBee Working Group, whose purpose is achieving a standard-compliant open-source implementation of ZigBee over TinyOS. In addition, he is involved in the CONET European Network of Excellence, in particular with the research cluster COTS-based architecture for QoS in large-scale distributed embedded systems. He is also actively participating as a reviewer or a program committee member in some reputed international journals, conferences and workshops dealing with real-time networks, quality-of-service, wireless communications, and related issues.



Maissa Ben Jamaa is a Master Student at the Faculty of Economics and Management of Sfax and subscribed to RedCad research unit at the National School of Engineering of Sfax (Research Unit on Development and Control of Distributed Applications). In 2008 and in the context of Nouha Baccour phd Thesis, Maissa completed her engineer degree in Computer Science with a final study project interesting in a comparative simulation study of link quality estimators in wireless sensor networks. The results of this collaborated work have been

published to MASCOTS2009 conference. Still working in the context of Nouha Baccour phd Thesis, Maissa is currently preparing her Master thesis dealing with link quality estimation in wireless sensor networks which has lead to numerous contributions published at EWSN10 conference and SensorNets09 school. You can visit Maissa homepage at this link: <http://www.redcad.org/members/maissa.benjamaa/>.



Denis Lima do Rosário was born in 1986 in Castanhal, Brasil. He received a degree in computer engineering at Instituto de Estudos Superiores da Amazônia in Brasil, in 2007. Currently he doing Master in Automation and Systems Engineering at Universidade Federal de Santa Catarina in Brasil. His research interests is in sensor networks and Link Quality Estimation.



Habib Youssef received a Diplôme d'Ingénieur en Informatique from the Faculté des Sciences de Tunis, University of El-Manar, Tunisia in June 1982 and a Ph.D. in computer science from the University of Minnesota, USA, in January 1990. From September 1990 to January 2001 he was a Faculty member of the computer engineering department of King Fahd University of Petroleum & Minerals (KFUPM), Saudi Arabia (Assistant Professor from 1990 to 1995 and Associate Professor from September 1995 to January 2001). From

February 2001 to June 2002, he was a Maitre de Conférences en informatique at the Faculté des Sciences de Monastir (FSM), University of Monastir, Tunisia. From July 2002 to August 2005, he served as the Director of the Institut Supérieur d'Informatique et Mathématiques of the University of Monastir. He is currently serving as a Professor of computer science and Director of the Institut Supérieur d'Informatique et des Technologies de Communication, Hammam Sousse, University of Sousse, Tunisia. Dr. Habib Youssef has over 130 publications to his credit in the form of books, book chapters, and journal and conference papers. He is the author with S. Sait of two books, (1) "VLSI Physical Design Automation: Theory and Practice", McGraw-Hill 1995, (also co-published by IEEE Press 1995), and reprinted with corrections by World Scientific in 1999, and (2) "Iterative Computer Algorithms with Applications in Engineering", IEEE CS Press 1999, and since 2003 published by John Wiley & Sons, which has also been translated into Japanese. His current research interests are computer networks, performance evaluation of computer systems, and algorithms for combinatorial optimization.



Mário Alves was born in 1968 and has a degree (1991), a M.Sc. (1995) and a Ph.D. (2003) in Electrical and Computer Engineering at the University of Porto, Portugal. He is a Professor in Electrical and Computer Engineering at the Polytechnic Institute of Porto (ISEP/IPP) and a Research Associate of the CISTER/IPP-HURRAY Research Unit, focusing on real-time, distributed and embedded computing systems. He participated in several international projects related to industrial communication systems (e.g. CCE-CNMA,

RFieldbus). He has been serving as a reviewer and publishing in top conferences (e.g. RTSS, ECRTS, ICDCS, OPODIS, MASS) and journals (e.g. IEEE TII, Elsevier ComNet, Springer RTSJ) in his expertise areas, got best paper awards (e.g. ECRTS'07) and supervised the EWSN'09 best M.Sc. Thesis award. He actively participated in the organization of several international conferences and workshops, e.g. IEEE WFCS'00 and ECRTS'03. His current research interests are mainly devoted to improving quality-of-service (QoS) in wireless sensor networks by using standard and commercial-off-the-shelf (COTS) technology (<http://www.hurray.isep.ipp.pt/ART-WiSe>, <http://www.open-ZB.net>). He is involved in international projects on networked embedded systems (ArtistDesign), cooperating objects (CONET), large-scale embedded monitoring using wireless sensor networks (EMMON) and cyber-physical systems for monitoring critical physical infrastructures (under the PT-CMU program).



Leandro Buss Becker was born in Alegrete, Brazil, in 1976. He has a bachelor degree in Computer Science (1997) from Federal University of Santa Maria and Master (1999) and Ph.D. (2003) from the Federal University of Rio Grande do Sul. His thesis was about a Real-Time Systems Design Methodology. In 2001 he had a research stay in the Real-time Systems and Communication Group (EuK) from the University of Magdeburg, Germany. Since 2004 he is an Associated Professor at the Department of Automation and Systems

Engineering of the Federal University of Santa Catarina (UFSC), Brazil. His research interests include Software Engineering for Real-time and

Embedded Critical Systems, Real-Time CPU/Message Scheduling, Wireless Communication in Mobile Systems, and Wireless Sensor Networks. He has coordinated a number of R&D projects on embedded and real-time systems, including real-time control systems, wireless communication, and design of embedded critical systems. Such projects were sponsored by the Brazilian Scientific Agency (CNPq) and local industries.